

REGADA s. r. o., Strojnícka 7, Prešov

Katalóg náhradných dielov

Typ MO, t.č. 52 000 s krokovou jednotkou

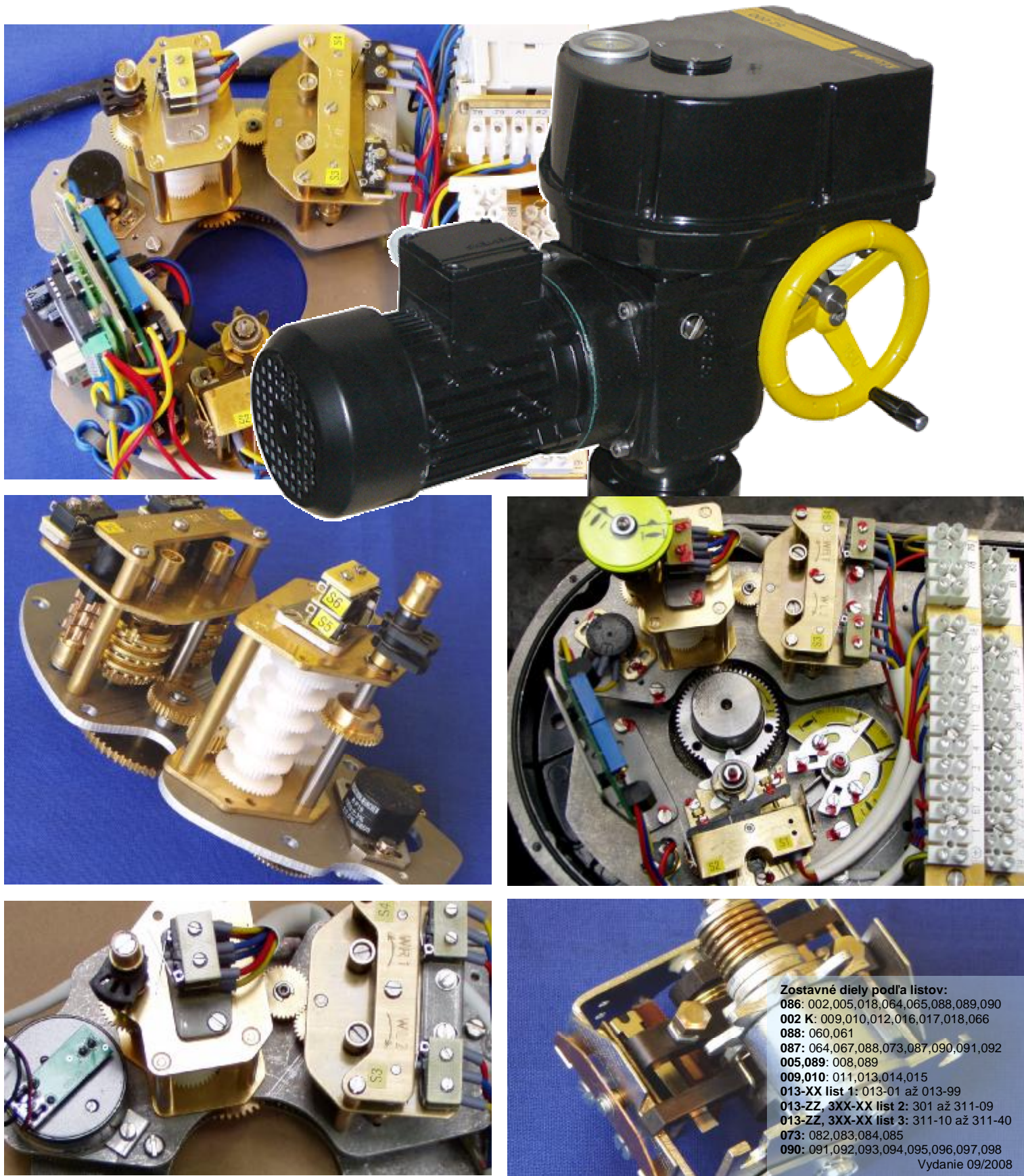

Zostavné diely podľa listov:
086: 002,005,018,064,065,088,089,090
002 K: 009,010,012,016,017,018,066
088: 060,061
087: 064,067,088,073,087,090,091,092
005,089: 008,089
009,010: 011,013,014,015
013-XX list 1: 013-01 až 013-99
013-ZZ, 3XX-XX list 2: 301 až 311-09
013-ZZ, 3XX-XX list 3: 311-10 až 311-40
073: 082,083,084,085
090: 091,092,093,094,095,096,097,098
Vydanie 09/2008

002-K Silový prevod MO 52 000 s KJ

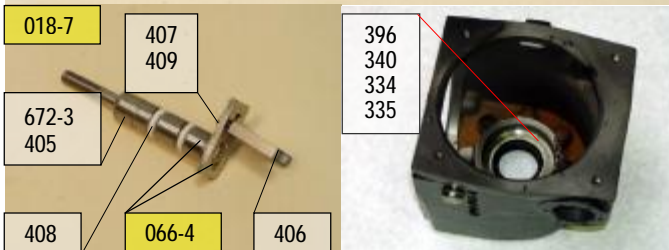
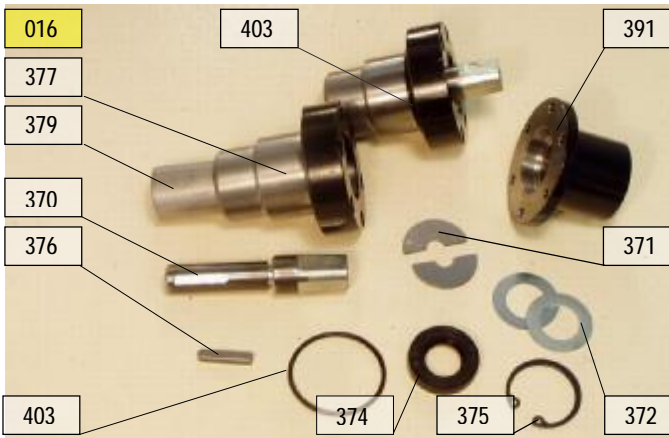
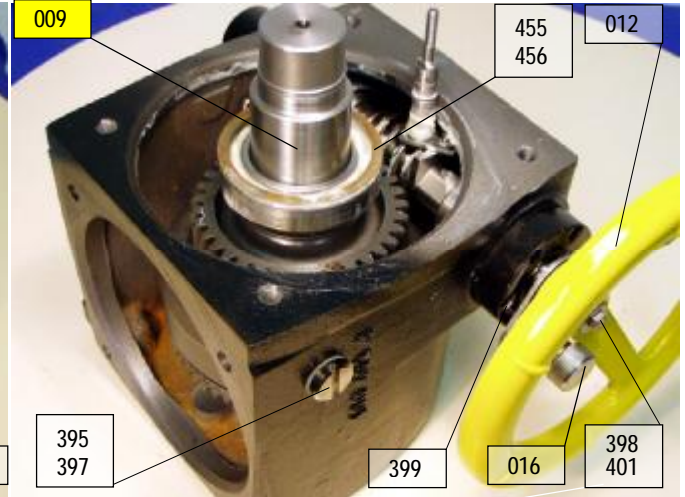
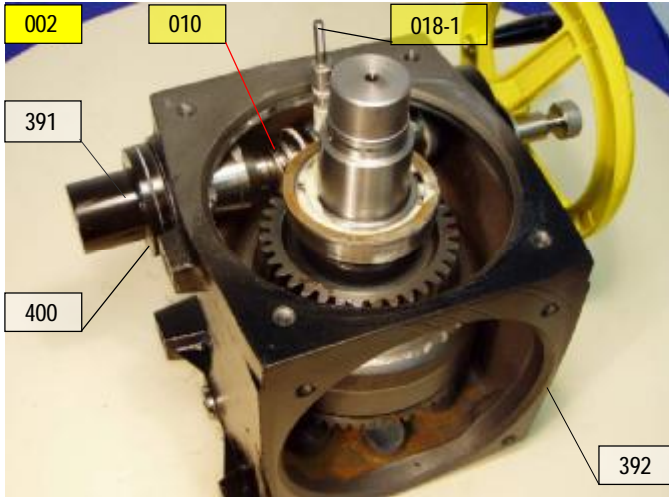

Poz.	Názov	PNm	Poznámky
002-11	PREVOD SILOVY	224563711	špec. text.
009-44	ZOSTAVA HRIADELA	224502544	špec. text.
010-XX	ZAVITOVKA ZOSTAVA	2245026XX	špec. text.
012-08	KOLESO RUCNE S VYREZO	224834608	
016-02	HRIADEL S ARETACIOU	224564202	
017-1	KLUKA ARETACIE	224A11101	
018-7	OVLADAC MOMENTOVY	224502707	
066-1	HRIADEL S PACKOU	224503101	
334	PODLOZKA	244511600	
335	PODLOZKA DISTANCNA	244517000	
340	LOZISKO 6008	663243024	
370-X	HRIADELKA	20463040X	špec. text.
371	SEGMENT	204630500	
372	PODLOZKA	204630600	
373	PUZDRO II S VLOZKOU-BEZOV	224581301	
374	KR_ZOKGUFERO 16X28X7	662735044	
375	KRUZOK POIST FE 28	663111801	
376	PERO 4X4X22	663152068	
377	PUZDRO II	204630302	
378	RUCNE KOLO /20DL01010/	244731800	
379	PUZDRO KU 20X30	663243161	
380	SKRUTKA ARETACIE	204970600	
381	KRUZOK 20X16	662732063	
382	RAMENO ARETACIE	204970800	
383	MATICA ARETACIE	204970700	
384	KRUZOK 6.9X1.8	662732191	
385-X	KOLESO RUCNE	24473170X	špec. text.
386	CAP RUKOVATE	244732000	
387	KRUZOK FE 5	663112049	
388	RUKOVAT 8	663210015	
389	PODLOZKA DISTANCNA	244831900	
390	PODLOZKA DISTANCNA	244832000	
391	KRYTKA	204867700	
392-2	SKRINA MO D 102 Rusko	204764002	špec. text.
395-1	ZATKA	244833701	
396	KRUŽOK GUFERO 40X52X7 GP	662735043	
397	PODLOZKA BA 50 D 14X19X2	662732325	
398	SKRUTKA FE M 5X12-A2	663117040	
399	SKRUTKA FE M 4X12-A2	663117805	
400	SKRUTKA FE M 4X20-A2	663117809	
401	PODLOZKA FE M 5,5-A2	663117400	
403	KRUZOK 34X2	662732109	
405	PACKA	244514100	
406	UNASAC	244514300	
407	PODLOZKA	244840200	
408	KRUŽOK 10X6 MVQ	662732022	
409	KRUZOK FE 3,2	663111720	
455	PODLOZKA DISTANCNA	244831600	
456	PODLOZKA DISTANCNA	244831700	
672-3	HRIADEL M. J.	244514403	

005,089 Riadiaca skriňa a kryt riadiacej skrine

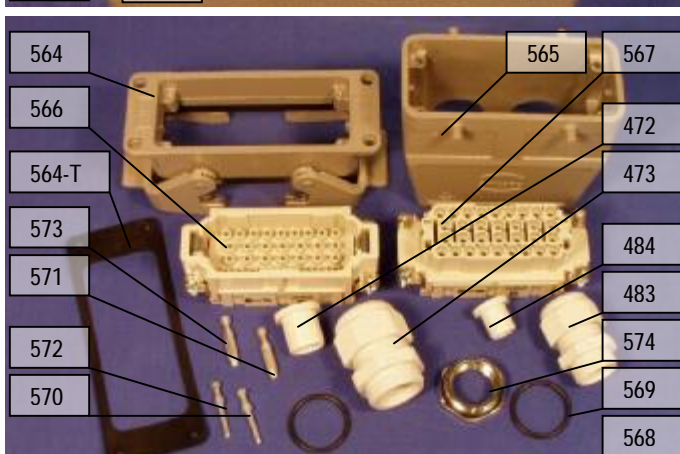
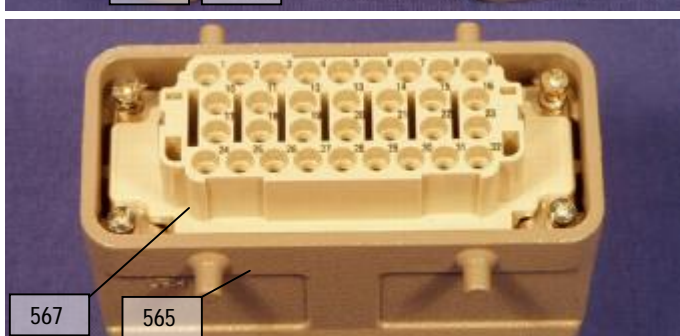
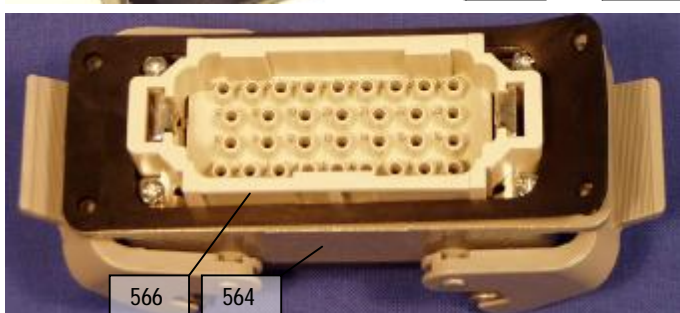
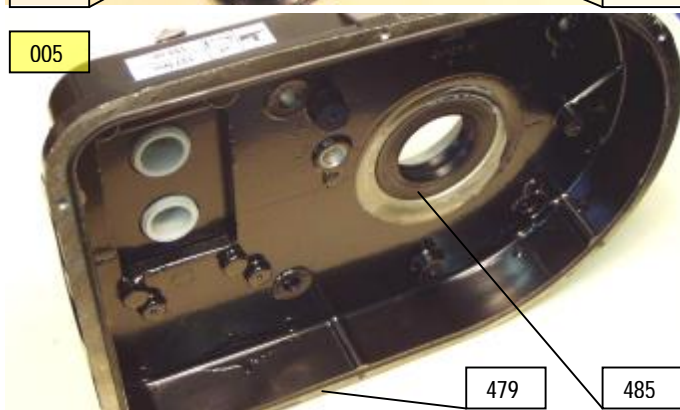
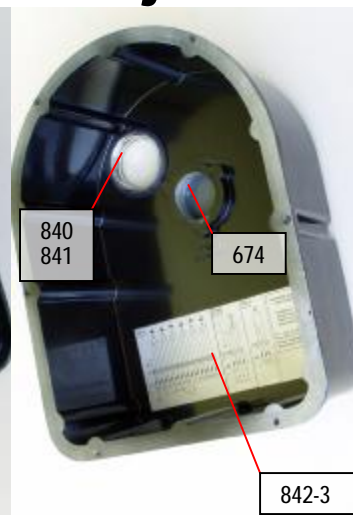
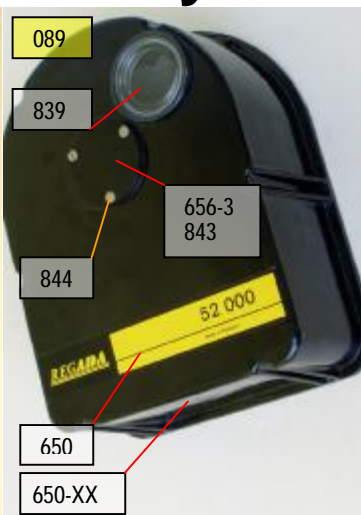
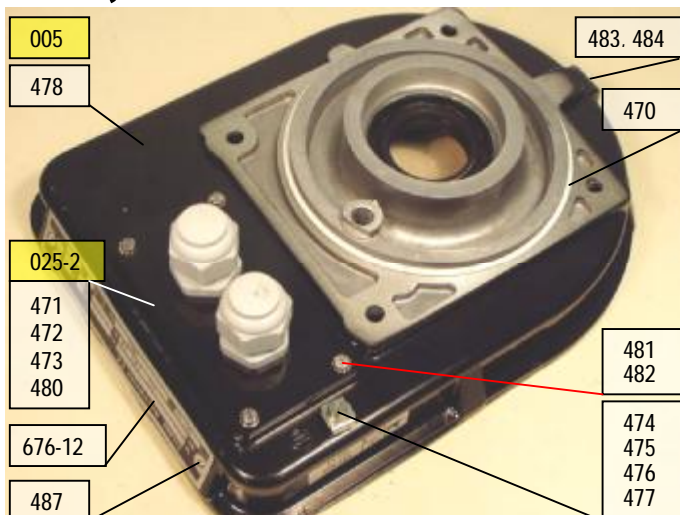

Poz	Názov	PNm	Poznámky
005-00	SKRINA RIADIACA-VYVODKY	224A21100	IP 65 52 000, 52 400.00
005-03	SKRINA RIADIACA-KONEKTOR	224A21103	IP 65 52 000, 52 400.00
005-21	SKRINA RIADIACA-VYVODKY	224A21121	IP 55 52 000, 52 400.00
005-24	SKRINA RIADIACA-KONEKTOR	224A21124	IP 55 52 000, 52 400.00
008-X	ZOSTAVA KONEKTOROV-HARTING	224A0020X	špec. textom
025-2	DOSKA S VYVODKAMI	224A20702	
089-XX	KRYT RIADIACEJ SKRINE IP 65	224A393XX	
470	KRUZOK 130X3	662732095	
471-2	DOSKA-OPRACOVANIE	204A01402	
472	OCHR. KRYTKA TESNIACA M25X1,5	663457028	
473	VÝVODKA KÁBELOVÁ M 25X1,5	663457017	
474	PODLOZKA	244503400	
475	PODLOZKA	244532500	
476	PODLOZKA FE M 5	663117452	
477	SKRUTKA MS M 5X10	663118109	
478-00	SKRINA RIADIACA IP 55 VYVODKY	204A78300	478-01 IP 55 KONEKT.
478-11	SKRINA RIADIACA	204A78311	IP 65 VYVO+ KONEKT.
479	TESNENIE RIADIACEJ SKRINE	604A05199	
480	TESNENIE DOSKY S VYVODKAMI	604A04799	tiež pri konek. vyhot.
481	SKRUTKA FE M 4X12-A2	663117735	
482	PODLOZKA MS 4,3	663118624	
483	VÝVODKA KÁBELOVÁ M 20X1,5	663457013	pri prepojení s motoro
484	OCHR. KRYTKA TESNIACA M20X1,5	663457025	pri prepojení s motoro
485	GUFERO GP 40X62X7	662735002	
487	RYH. KLINEC FE 2,49X4,76-NI	663111904	
564	KRYT PANELOVY HAN 16B	663456695	
564-T	KRYT PANELOVY HAN 16B	663456695	tesnenie súčasťou
565	TELESO KONEKT. M25 BOČNE	663456755	
566	ZASUVKA HAN 32 EE-M	663456713	
567	VIDLICA HAN 32 EE-F	663456712	
568	KRUZOK 22X2	662732046	
569	KRUZOK 20X2	662731034	
570	KOLIK 0.5 MM2	663456714	
571	DUTINKA 0.5 MM2	663456715	
572	KOLIK 1 MM	663456718	
573	DUTINKA 1 MM	663456719	
574	REDUKCIA RS-MSM25X1.5/M20X1.5	663457081	
575	SKRUTKA MS M 4X20	663118106	upevnenie konektora
579	SVORKOVNICA LTA 12-4 OP TXP310P	663456709	
583-12	STITOK SVORKOVNICE	204959612	
583-13	STITOK SVORKOVNICE	204959613	
583-14	STITOK SVORKOVNICE	204959614	
583-15	STITOK SVORKOVNICE	204959615	
650-XX	KRYT RIAD. SKRINE	2046062XX	
651-3	SCHEMA ZAPOJENIA Z 298 spínače	244570403	651-4 Z 279A, -5 Z296
652	SCHEMA ZAPOJENIA Z 6A B2	204976400	
656-3	VEKO-CIERNE	244532703	
656-X	VEKO-CIERNE	24453270X	
657	TESNENIE	244532100	
658	SKRUTKA FE M 4X10-A2-70	663117804	
674	KRUZOK 43X35 MVO	662732099	
674	KRUZOK 43X35 MVO	662732099	
675-1	STITOK REGADA 52 000	644540001	
676-12	STITOK TYPOVY 52 000 (s naraz. údajmi)	244524112	nákup 644524112
839	PRIEZOR	604659200	
840	VLOŽKA PRIEZORU	204A74900	
841	KRUZOK 42X2	662732107	
842-X	SCHEMA ZAPOJENIA	20499250X	03-Z323A,
843	KRUZOK 38X2	662732037	
844	SKRUTKA MS M4X10	663118222	

009-XX Zostava hriadeľa 224 5025 XX

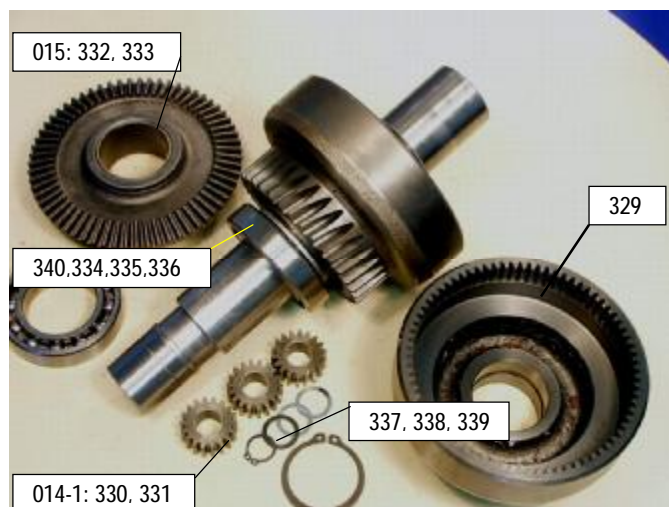
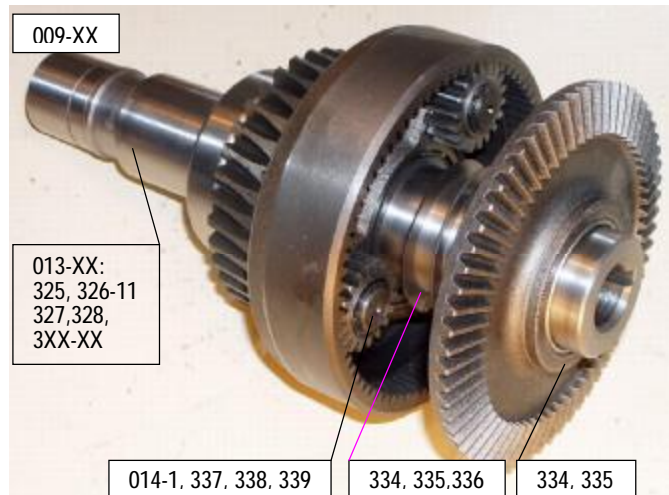

010-21 Závítovka zostava 224 5026 21(XX)

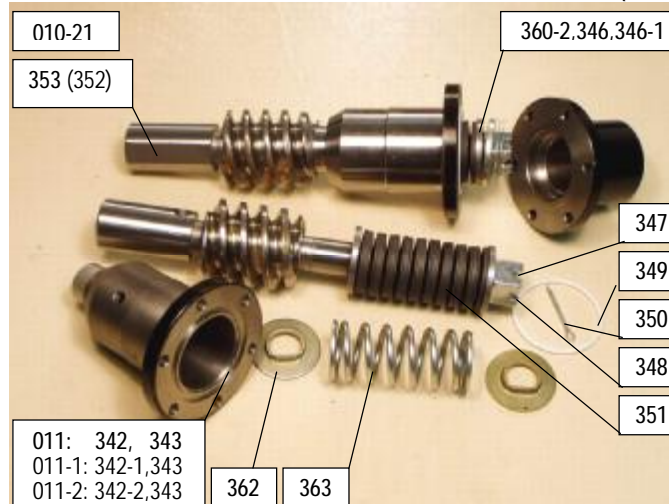

009-XX	Zostava hriadeľa	2245025XX	špecifikovať textom
010-XX	Závítovka zostava	2245026XX	špecifikovať textom
011	Puzdro s vložkou	224581400	
011-1	Puzdro s vložkou	224581401	
011-2	Puzdro s vložkou	224581402	
013-XX	Hriadeľ s unášačom	2245024XX	viď 013-XX
014-1	Satelit	224502901	
015	Koleso kuželové	224503000	
3XX-XX	Výstupný hriadeľ	2XXXXXX	viď 3XX-XX

325-13	Unášač 3 drážky	244511913	v 013-XX
326-11	Čap	244512011	v 013-XX
327	Kružok poistný FE 40	663111966	v 013-XX
328	Pero 8x7x20	663152070	v 013-XX

010-XX Závítovka zostava 224 5026 XX

List 1/1

02	341-1,345,346,347,348,349,350,352,354,355,356,357,359
03	341-1,346,347,348,349,350,352,354,355,356,357,359
04	341-1,346,347,348,349,350,352,354,355,356,358,359
05	341-1,345,346,347,348,349,350,352,354,355,356,359
06	341-1,346,347,348,349,350,352,354,355,356,359
07	341-1,346,347,348,349,350,352,354,355,356,358,359
08	341-1,345,346,347,348,349,350,352,354,355,356,359
10	341-3,345,346,347,348,349,350,352,354,355,356,359
11	346,346-1,347,348,349,350,353,359,360-3,011
12	346,346-1,347,348,349,350,353,359,011,360-2
13	346,346-1,347,348,349,350,353,359,011,360-2
14	346,346-1,347,348,349,350,353,359,011,360-2
15	346,346-1,347,348,349,350,353,359,011-1,360-2
16	346,346-1,347,348,349,350,353,359,011,360-2
17	346,346-1,347,348,349,350,353,359,360-3,011
18	346,346-1,347,348,349,350,353,359,011,360-2,360-3
19	346,346-1,347,348,349,350,353,360-3,011,361
20	346,346-1,347,348,349,350,353,360-3,011,362,363
21	346,346-1,347,348,349,350,351,353,360-2,011
22	346,347,348,349,350,353,351,360-3,011
23	347,348,349,350,353,011,360-2,362,364
24	347,348,349,350,353,011,360-2,362,365
25	347,348,349,350,353,011,360-2,368
26	347,348,349,350,353,011,360-2,362,363,366
27	347,348,349,350,353,360-3,011,367,369
28	346,347,348,349,350,353,360-3,011
29	346,347,348,349,350,351,353,360-3,011-2
30	346,346-1,347,348,349,350,353,358,011-2

329	Veniec	244512700
330	Satelit	204843100
331	Puzdro KU 1412	663243150
332	Koleso kuželové	244512200
333	Ložisko KU 40x30	663249037
334	Podložka	244511600
335	Podložka dištančná	244517000
336	Podložka	244517300
337	Podložka	244868901
338	Podložka	244868902
339	Kružok poistný FE 14	663111943
340	Ložisko 6008	663243024
341	Puzdro	244513600
342-X	Puzdro	20462960X
343	Puzdro KU 14x15	663243160
344-2	Rozperka	244508902
345	Podložka	244513300
346	Podložka s=0,2	244513400
346-1	Podložka s=0,3	244513401
347	Matica	244513500
348	Podložka	244538900
349	Kružok 3167 32x2	662732097
350	Zavlačka	663111756
351	Pružina TF 25x12,2x0,96x1,6	663152158
352	Závítkový hriadeľ	244512800
353	Závítkový hriadeľ	204867600
354	Zátka	244513700
355	Podložka dištančná	244832700
356	Podložka dištančná	244832800
357	Podložka upch. P21x20	662731060
358	Podložka	244519200
359	Pružina TF 25X12,2X0,7X1,6	663152071
360-2	Rozperka	244506902
360-3	Rozperka	244506903
361	Pružina TF 23X12,2X1,0	663152075
362	Podložka pre valcové pružiny	244891800
363	Pružina	644867100
364	PRUŽINA TL 3150X232X0480	663152189
365	PRUŽINA TL 2500X225X0530	663152191
366	RURKA VYMEDZOVACIA	204721300
367	PRUŽINA TL 3150X192X0500	663152190
368	PRUŽINA TL 2000X180X0530	663152192
369	Pružina 28X12,2X1,25 GR2	663152156

Poznámka: Dielce pre jednotlivé vyhotovenia závítovky sú rozpísané v hornej tabuľke ale nie sú všetky zobrazené.

XX	325-XX Unášač 244 5119 XX	326-11 Čap 244 5120 11	327 Kr. po 40	328 Pero 8x7x20	3XX-XX Výstupný hriadel'		Poznámky 1	Poznámky 2
01	12	+	+	+	301	244 5393 00	L=243,5 2P 4zu30 ⁰	MO diera skrz Ø28
02	12	+	+	+	302	204 9243 00	L=180,6 2P, 2 zu14	T-C, koniec Ø30,3/17
03	12	+	+	+	303	244 5118 00	L=253,5 2P 4zu30 ⁰	MO diera skrz Ø28
04	-							
05	12	+	+	+	304	244 5371 00	L=181 2P 4zu30 ⁰	die skrz Ø28 koniec Ø30,3/17
06	12	+	+	+	305	244 5503 00	L=239,1 2P PØ25P8	MP plný
07	12	+	40,26, 32	+	306 307	244 6051 00 244 6052 00	L=247, MP-E L=262, Ø11 tyč	Základné vyhotovenie
08	-							
09	12	+	+	+	308	204 6140 00		Nemá výkres v systéme
10	-							
11	11	+	+	+	309	244 9468 00	L=243,5 4P 4zu30 ⁰	MO diera skrz Ø28
12	12	+	+	+	310	244 5392 00	L=253,5 2P, 2 zu14	MO-Ex T-C diera skrz Ø28
13	13	+	+	+	311-28	204 A013 28	L=250,5 3P DØ25P8	diera, plný kon MO 3.5, kr.je.
14	12	+	+	+	305-01	244 5503 01	L=239,1 2PPØ252P8	MP závora plný s M8 a 2P8
15	12	+	+	+	313	204 8578 00	L=234,6 2P PØ25P8	MP plný, závit M4 na konci
16	11	+	+	+	314-01	244 9942 01	L=253,5 4P, 4zu45 ⁰	MO-Ex T-C diera skrz Ø28
17	11	+	+	+	309-01	244 9468 01	L=253,5 4P 4zu30 ⁰	MO-Ex diera skrz Ø28
18	11	+	+	+	315	204 8551 00	L=243,5, 4P, T-C	01: L=253,5, 4P, T-C
19	12	+	+	+	316	204 9125 00	L=220,6 2P, Ø25P8	MP plný ,koniec Ø30,3/17
20	12	+	+	+	310-01	244 5392 01	L=243,5 2P, 2 zu14	MO T-C diera skrz Ø28
21	11	+	+	+	317	204 9306 00	L=296,5 4P, Ø20P6	P-1103/02
22	11	+	+	+	315-01	204 8551 01	L=253,5, 4P, T-C	03 L=180,7 4P T-C, Ø30/17 04 L=243,5 4P T-C MO
23	11	+	+	+	317-01	204 9306 01	L=233,7 4P, Ø20P6	P-1103/02, T-C, Ø30/17
24	11	+	+	+	315-04	204 8551 04	L=243,5 4P, Ø15P5	MO,T-C Ø15H8
25	11	+	+	+	302-01	204 9243 01	L=180,6 4P, 4xzub	MO, 4xzub, CPT, Ø30/17
26	11	+	+	+	315-03	204 8551 03	L=180,7 4P, Ø20P6	MO,P-1103/03T-E,CPTØ30/17
27								
28								
29								
30								
31	Tri drážky 13	+	+	+	311-00	204 A013 00	L=243,5 3P 4xzub	MO, 4x45 Rusko
32	Tri drážky 13	+	+	+	311-01	204 A013 01	L=253,5 3P 4xzub	MO-Ex, 4x45 Rusko
33	Tri drážky 13	+	+	+	311-02	204 A013 02	L=243,5 3P 4xzub	MO-MT, 4x30 Rusko
34	Tri drážky 13	+	+	+	311-03	204 A013 03	L=243,5 3P Ø20P6	MO Mapol
35	Tri drážky 13	+	+	+	311-04	204 A013 04	L=253,5 3P Ø20P6	MO-Ex Mapol
36	Tri drážky 13	+	+	+	311-05	204 A013 05	L=180,7 3P Ø20P6	MO, CPT Ø30,3/17
37	Tri drážky 13	+	+	+	311-06	204 A013 06	L=243,5 3P Ø15P5	MO
38	Tri drážky 13	+	+	+	311-09	204 A013 09	L=180,7 3P 2 zu14	MOCPT+Kotúč 204A64600
39	Tri drážky 13	+	+	+	311-10	204 A013 10	L=180,7 3P 4zu45 ⁰	MOCPT+Kotúč 204A64600
40	Tri drážky 13	+	+	+	311-11	204 A013 11	L=253,5 3P 4zu30 ⁰	MO,MT-Ex 4x30
41	Tri drážky 13	+	+	+	311-12	204 A013 12	L=239,1 3P PØ25P8	MP plný hriadel'
42	Tri drážky 13	+	+	+	311-13	204 A013 13	L=239,1 3P PØ20,9P8	MP plný hriadel' 2x pero P8
43	Tri drážky 13	+	+	+	311-14	204 A013 14	L=228,6 3P PØ25P8	MP, MPR CPT, c
44	Tri drážky 13	+	+	+	311-15	204 A013 15	L=180,7 3P 4zu30 ⁰	MO, MT CPT 4x30, Ø31/17
45	Tri drážky 13	+	+	+	311-16	204 A013 16	L=253,5 3P 2 zu14	MO-Ex drážka 14
46	Tri drážky 13	+	+	+	311-17	204 A013 17	L=243,5 3P 2 zu14	MO drážka 14
47	Tri drážky 13	+	+	+	311-18	204 A013 18	L=296,5 3P PØ20P6	Plný hriadel' 1103/02
48	Tri drážky 13	+	+	+	311-19	204 A013 19	L=233,7 3P PØ20P6	Plný hriadel' 1103/02, Ø30,3/17
49	Tri drážky 13	+	+	+	311-20	204 A013 20	L=234,6 3P PØ25P8	Plný hr. MPR, OV
50	Tri drážky 13	+	+	+	311-21	204 A013 21	L=244,5 3P 4zu45 ⁰	MO 4x45 Rusko IP55
51	Tri drážky 13	+	+	+	311-22	204 A013 22	L=244,5 3P 4zu30 ⁰	MO MT 4x30 Rusko IP55
52	Tri drážky 13	+	+	+	311-25	204 A013 25	L=244,5 3P 2 zu14	MO drážka 14
53	Tri drážky 13	+	+	+	311-26	204 A013 26	L=240,5 3P DØ25P8	MO 3.5 D25 diera s perom 8
54	Tri drážky 13	+	+	+	311-27	204 A013 27	L=177,7 3P DØ25P8	MO3.5P,diera s P8, Ø30,3/17
55	Tri drážky 13	+	+	+	311-29	204 A013 29	L=180,7 3P D20x20	Diera 20x20, Ø30,3/17
56	Tri drážky 13	+	+	+	311-30	204 A013 30	L=253,5 3P D20x20	MO-Ex Diera 14x14
57	Tri drážky 13	+	+	+	311-31	204 A013 31	L=339,5 3P PØ30P8	MO Plný hriadel'
58	Tri drážky 13	+	+	+	311-35	204 A013 35	Ø00-6,9-22,25-43	MO 25x25
59	Tri drážky 13	+	+	+	312	204 B093 00	L=214 3P DØ25P8	diera, plný kon MO 3.5, kr.je.
60	Tri drážky 13	+	+	+	311-36	204 A013 36	L=217,5 3P DØ20P6	Plný hr. MO 20/6 krok.j.
61	Tri drážky 13	+	+	+	311-42	204 A013 42	L=244,5 3P 2 zu14	MO vrtanie Ø29,2, dráž. 14
62	Tri drážky 13	+	+	+	311-43	204 A013 43	L=243,5 3P DØ22P6	MODiera ØD22, 2P6 Ma
63	Tri drážky 13	+	+	+	311-41	204 A013 41	L=293,5 3P 4zu30 ⁰	MO,MT 4x30, krok.j.
64	Tri drážky 13	+	+	+	311-40	204 A013 40	L=293,5 3P 4zu45 ⁰	MO,MT 4x45 krok.j.
99	Tri drážky 13	+	+	+	-	Bez hriadela		MO 3.3

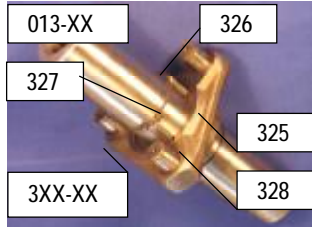

301 (L=243,5 2xP 4zu30°) 302 (L=180,6; 2xP; TVAR C) 303 (L=253,5 2xP 4zu30°)

--	--	--	--

304 (L=181 2P 4zu30°) 305 (L=239,1 2P PØ25P8) 306,307(L=247. MP-F. L=262. Ø11 tvč) 308(.....)

--	--	--	--

309 (L=243,5 4P 4zu30°) 310(L=253,5 2P, 2 zu14) 311-28 (L=250,5 3P DØ25P8) 305-01 (L=239,1 2PPØ252P8)

--	--	--	--

313 (L=234,6 2P PØ25P8) 314-01(L=253,5 4P, 4zu45°) 309-01(L=253,5 4P 4zu30°) 315 (L=243,5, 4P, T-C)

--	--	--	--

316 (L=220,6 2P, Ø25P8) 310-01(L=243,5 2P, 2 zu14) 317(L=296,5 4P, Ø20P6) 315-01 (L=253,5, 4P, T-C)



317-01 (L=233,7 4P, Ø20P6) 315-04 (L=243,5 4P, Ø15P5) 302-01 (L=180,6 4P, 4xzub) 315-03 (L=180,7 4P, Ø20P6)

--	--	--	--

311-00 (L=243,5 3P 4xzub) 311-01 (L=253,5 3P 4xzub) 311-02 (L=243,5 3P 4xzub) 311-03 (L=243,5 3P Ø20P6)

--	--	--	--

311-04 (L=253,5 3P Ø20P6) 311-05 (L=180,7 3P Ø20P6) 311-06 (L=243,5 3P Ø15P5) 311-09 (L=180,7 3P 2 zu14)

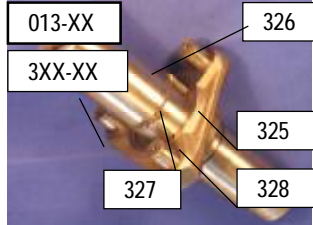

311-10 (L=180,7 3P 4zu45⁰) 311-11 (L=253,5 3P 4zu30⁰) 311-12 (L=239,1 3P PØ25P8)

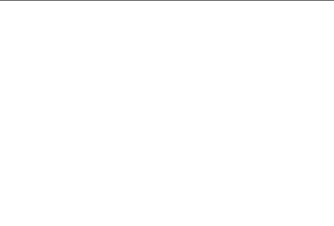

311-13 (L=239,1 3P PØ20,9P8) 311-14 (L=228,6 3P PØ25P8) 311-15 (L=180,7 3P 4zu30⁰) 311-16 (L=253,5 3P 2 zu14)



311-17 (L=243,5 3P 2 zu14) 311-18(L=296,5 3P PØ20P6) 311-19(L=233,7 3P PØ20P6) 311-20 (L=234,6 3P PØ25P8)

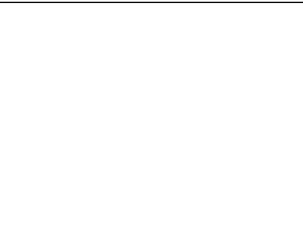
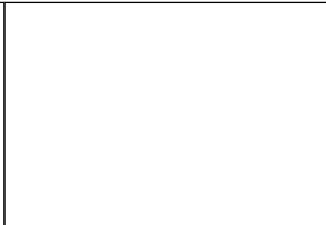

311-21 (L=244,5 3P 4zu45⁰) 311-22 (L=244,5 3P 4zu30⁰) 311-25(L=244,5 3P 2 zu14) 311-26 (L=240,5 3P DØ25P8)

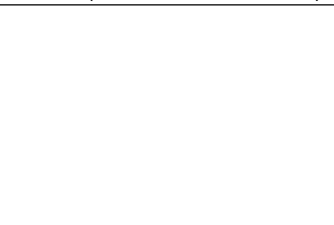
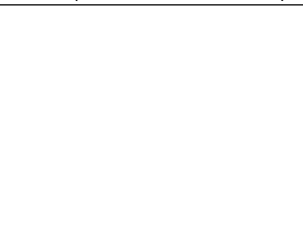

311-27 (L=177,7 3P DØ25P8) 311-29 (L=180,7 3P D20x20) 311-30(L=253,5 3P D20x20) 311-31 (L=339,5 3P PØ30P8)

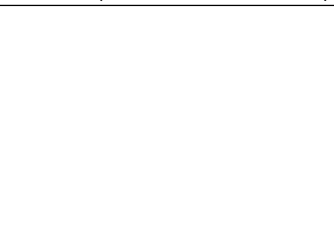
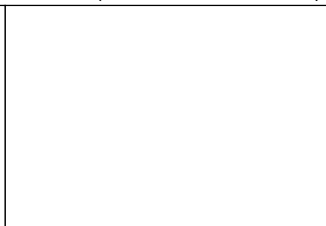
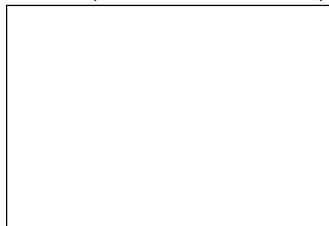

311-35 (MO 25x25) 312 (L=214 3P DØ25P8) 311-36(L=217,5 3P DØ20P6) 311-42 (L=244,5 3P 2 zu14)

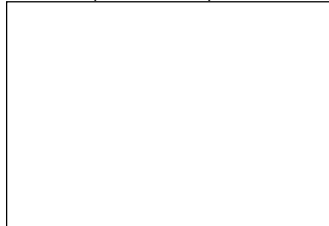

311-43 (L=243,5 3P DØ22P6) 311-41 (L=293,5 3P 4zu30⁰) 311-40 (L=293,5 3P 4zu45⁰) (.....)

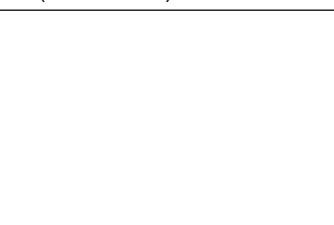
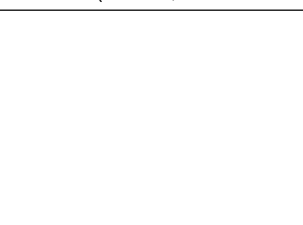
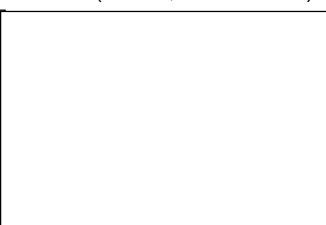
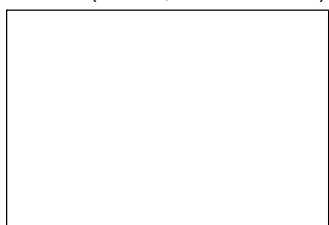

(.....)

(.....)

(.....)

(.....)

073-10 Momentová jednotka

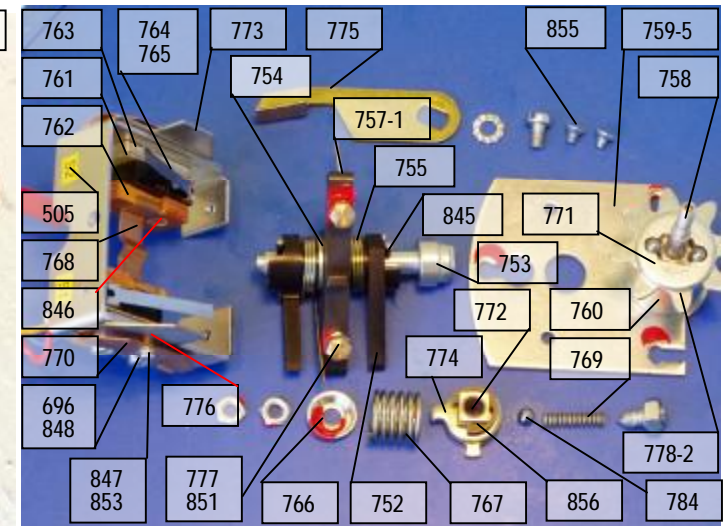
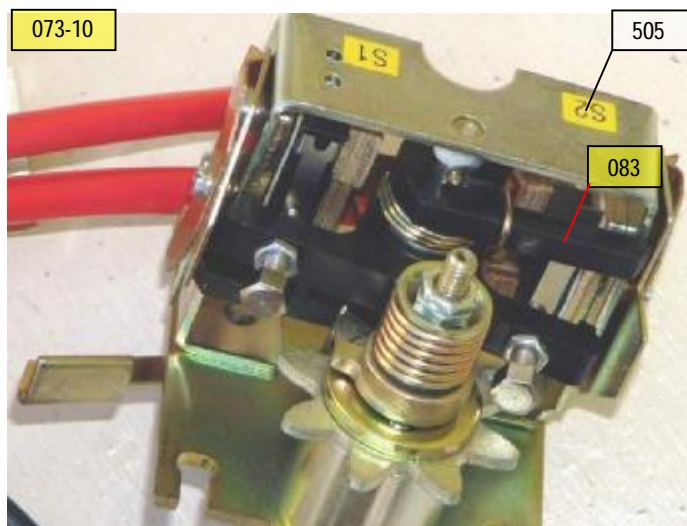
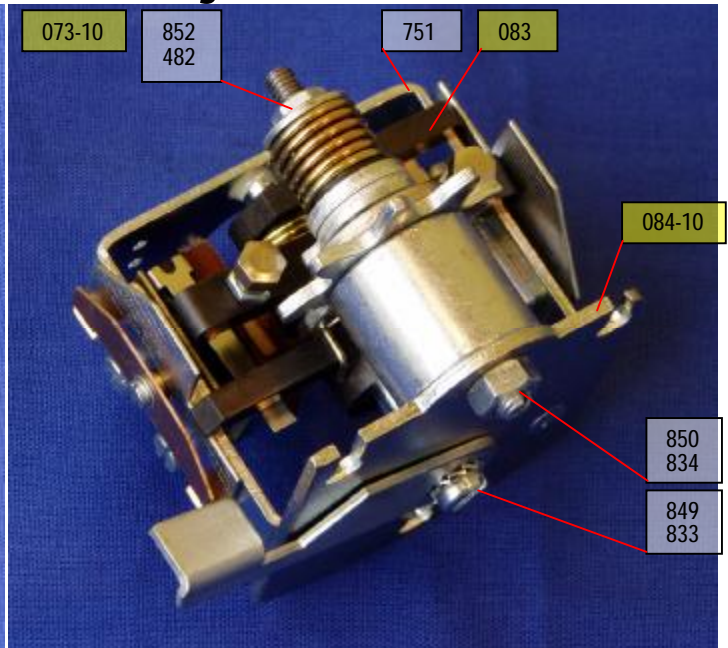
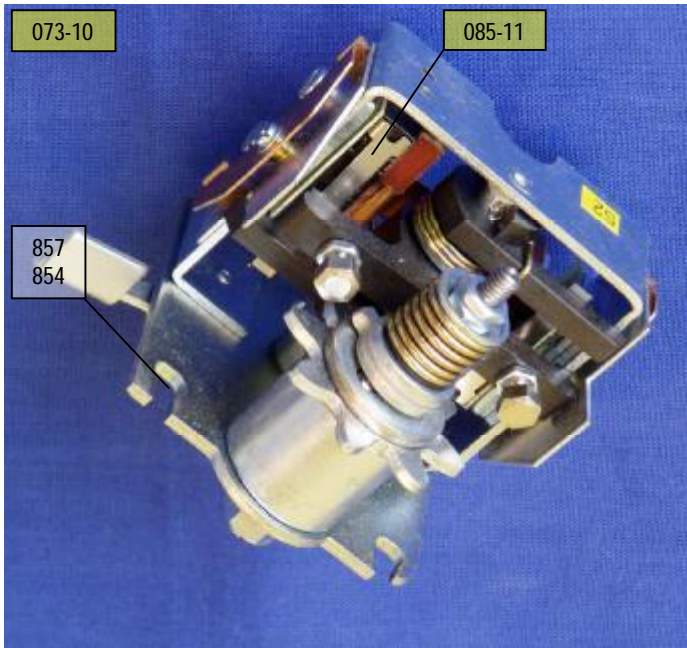

Poz.	Názov	PNm	Poznámky
073-10	MOMENTOVA JEDNOTKA	224743710	
083-11	ZOSTAVA PAČKY	224500611	
084-10	DOSKA MOMENTOVEJ JEDNOTKY	224500710	
085-11	ZOSTAVA SPINAČOV	224744011	
482	PODLOZKA MS 4,3	663118624	
505-1	STITOK OZNAC. MSP	604680901	505-2 604680902
696	PODLOZKA 3,2 A2	663118600	
751-1	NOSNÍK VYPÍNAČOV	204541901	
752	PAKA VYPÍNACIA	244504200	
753-1	HRIADELKA	244504301	
754-1	PODLOZKA	244529701	
755-1	PRUŽINA	644503601	
757-1	PAČKA	204540701	
758-2	OS	244503902	
759-5	DOSKA MOMENTOVEJ JEDNOTKY	244504405	
760-3	ROZPIERKA	244503703	
761	DOSKA IZOLAČNA MO	204778100	
762	DOSKA MO	204778200	
763-1	PLECH MO	204778300	
764	MIKROSPINAC DB 6G-B1 BA BEZ PAČKY	664051219	
765	ZUSATZBETATIGER 6141273 PAČKA	664051415	
766-1	PODLOZKA	244503801	
767-1	PRUŽINA	644504501	
768	PERO	244504600	
769-1	PRUŽINA	644504701	

Poz.	Názov	PNm	Poznámky
770	PERO	244504800	
771-1	VODITKO	244504901	
772	LOŽISKO	244505200	
773-1	ZARÁŽKA	244505301	
774-1	VAČKA	244505401	
775-1	PAČKA	244505501	
776-1	ROZPIERKA	244505601	
777	SKRUTKA	244917800	
778-2	PASTOROK	244946602	
784	GULIČKA	663249013	
833	PODLOZKA 4 - BRASS EIJ	663118590	
834	MATICA M5	663118400	
845	KOLIK FE M 2x10	663117507	
846	SKRUTKA MS M2X12	663118008	
847	SKRUTKA MS M2X5	663118005	
848	SKRUTKA MS M3X5	663118012	
849	SKRUTKA M4X6-A2-70	663117013	
850	SKRUTKA FE M5X12	663117200	
851	MATICA MS M3	663118394	
852	MATICA MS M4	663118399	
853	PODLOZKA B MS 2,2	663118587	
854	PODLOZKA B MS 3,2	663118623	
855	SKRUTKA MS M3X5	663118190	
856	KRUZOK FE 6-A2	663117653	
857	SKRUTKA MS M3X8	663118099	

086 Elektrický servopohon MO 52 000 s KJ

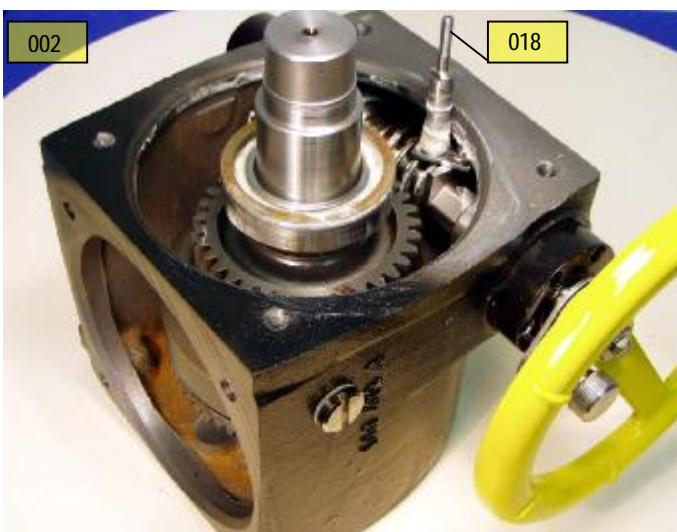
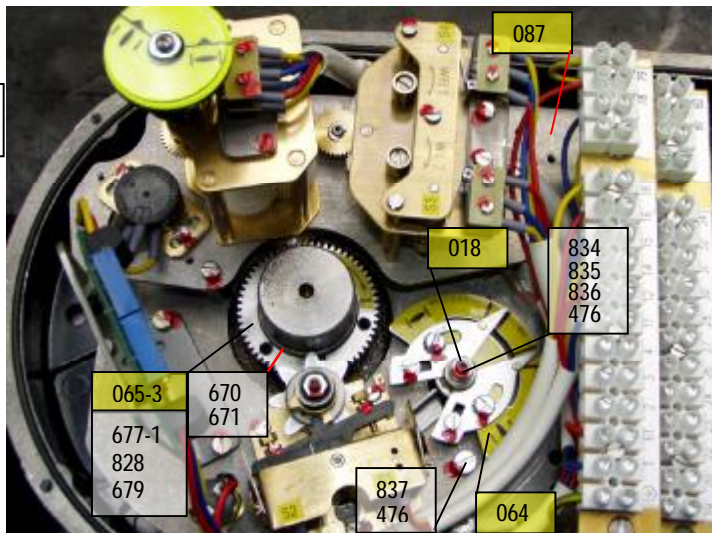
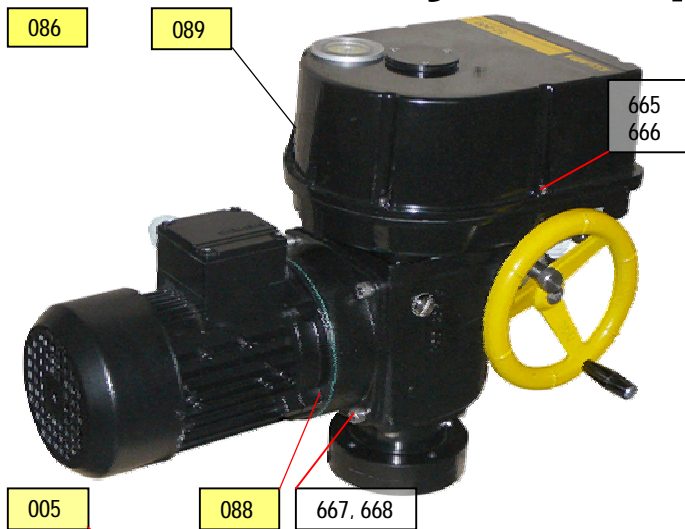

Poz	Názov	PNm	Poznámky
002-XX	SILOVÝ PREVOD	2245637XX	špec. text.
005-X	SKRINA RIADIACA	224A2110X	špec. text.
018-7	MOMENTOVÝ OVLADAC	224502707	špec. text.
064	MOMENTOVÝ VYPINACI KOTUC	224783600	
065-3	KOLESO OZUBENE 1 KOLIK	224506203	
086-XX	EL. SERVOPOHON MO 52 000 s KJ	2245815XX	špec. text.
087-XX	OVLADACIA DOSKA s krokovou jednot.	224A551XX	špec. text. vo vyh.
088-XX	ELEKTROMOTOR ZOSTAVA+ZDRZ	2245033XX	špec. text.
089-X	KRYT RIADIACEJ SKRINE	224A393XX	špec. text.
090	KJ-PJ MO ZOSTAVA	224A54100	
476	PODLOZKA FE M 5	663117452	
525	PODLOZKA FE 8-ZN	66311734	
665	SKRUTKA FEM 4x20-A2	663117130	
666	PODLOZKA M 4-A2	663117451	
667	SKRUTKA FEM 8x20-A2	663117170	
668	PODLOZKA M 4-A2	663117454	
670	POISTNY KRUZOK	644834100	
671	PERO 3H9x3x6	663152038	
677-1	KOLESO OZUBENE	244512501	
679	ŠTITOK O - Z	604A10500	
705	VLOŽKA	204952700	
828	KOLIK FE M 4X24	663117534	
834	MATICA M5	663118400	
835	MATICA M5	663118401	
836	PODLOZKA 5 - 200 HV - A2	663112954	
837	SKRUTKA M5x12 - A2 - 70	663117024	
XXX	OLEJ PREVODOVY PP 80	661112034	
XXX	MAZACI TUK GLEIT HP 571-2	661112055	
XXX	MAZACI TUK GLEIT HF 401/0	661112054	

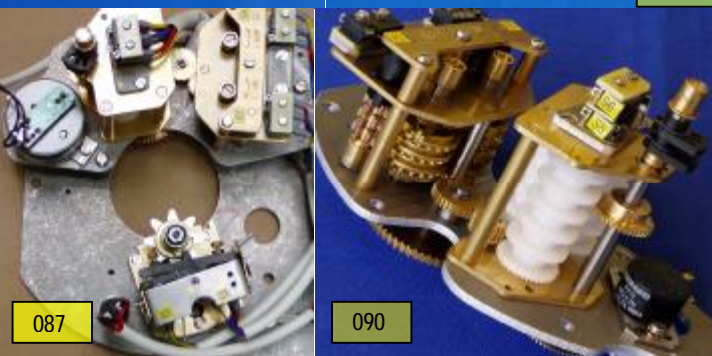
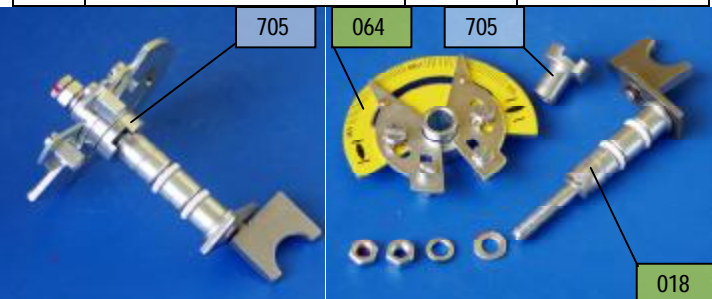
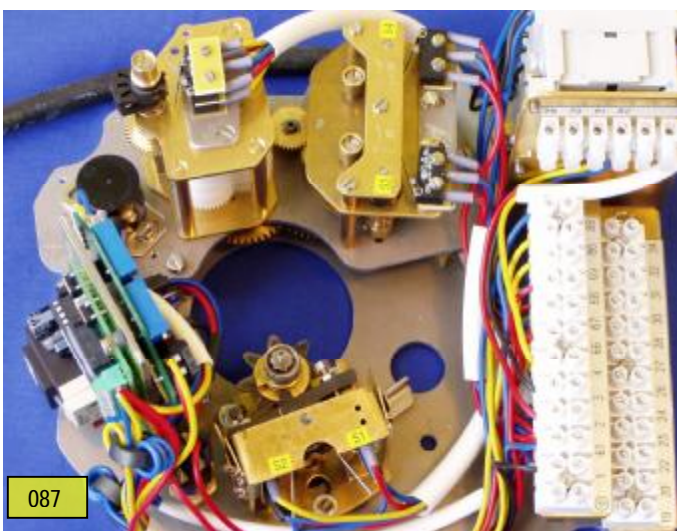

087 Ovládací doska MO s krok. jednotkou

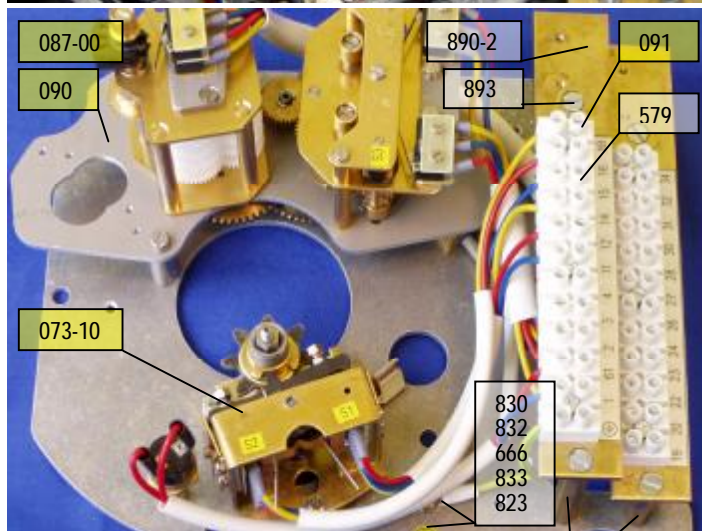
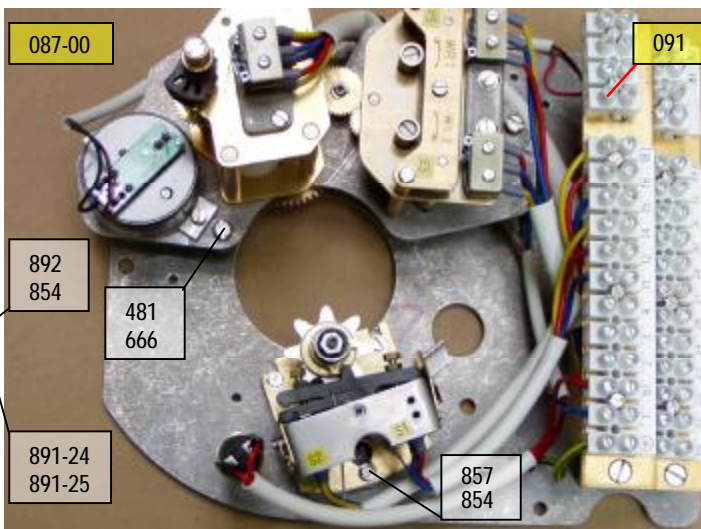
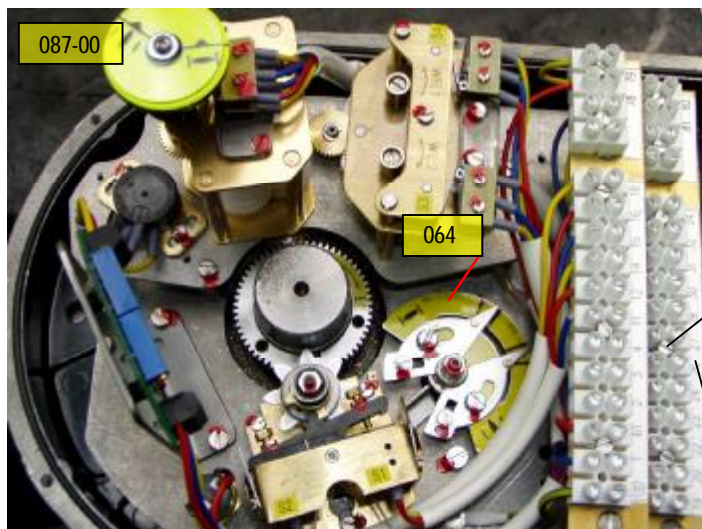

Poz	Názov	PNm	Poznámky
064-1	MOMENTOVY VYPINACI KOTUC	224783601	
067-1	DOSKA S PUZDROM	224783701	
068-1	DORAZ S KOLIKOM	224783801	
073-10	MOMENTOVA JEDNOTKA	224743710	
087-00	OVLADACIA DOSKA s krok. jednotkou	224A55100	bez vysielaca
090	KJ-PJ MO ZOSTAVA	224A54100	
091	SVORKOVNICA ZOSTAVA	224A54200	
092	ODPOR RH 50	224A54200	
481	SKRUTKA FE M 4X12-A2	663117735	
482	PODLOZKA MS 4,3	663118624	
579	SVORKOVNICA LTA 12-4 OP TXP310P	663456709	
666	PODLOZKA M 4-A2	663117451	
680-1	DOSKA	204899301	
681-1	PUZDRO	244506301	
681-2	PUZDRO	244506302	
682-1	DORAZ	204899401	
683-2	CAP	204955602	
684-1	DORAZ	244506201	
687	NALEPKA MJ	604951200	
823	STITOK OCH. UZEMNENIA	604811900	
824	STLPIK NITOVACI M4/21,5	204A10901	
825	STLPIK NITOVACI M3/L7	204A10918	
826	STLPIK SPINACI UP 1	204A90400	
827	DOSKA MO	204B09600	
829	SKRUTKA MS M3X6 TVAR A	663118014	
830	SKRUTKA MS M4X8	663118125	
831	PODLOZKA B MS 3,2	663118589	
832	OKO KABELOVE 7610-03/4	663456345	
833	PODLOZKA 4 - BRASS EIJ	663118590	
838	SPINAC TEPELNY 2455R-T850-B226	663453061	
854	PODLOZKA B MS 3,2	663118623	
857	SKRUTKA MS M3X8	663118099	
886	PODLOZKA FE M3-A2	663117450	
888	ODPOR RH 50 1% 1500 R	663710863	
889-5	STLPIK DISTANCNY L 36	204952605	
889-6	STLPIK DISTANCNY L 56	204952606	
890-2	PLECH SVORKOVNICE	204952202	
891-24	STITOK SVORKOVNICE	204959624	
891-25	STITOK SVORKOVNICE	204959625	
892	SKRUTKA M3X14-A2-70	663117011	
893	SKRUTKA MS M4X8	663118221	

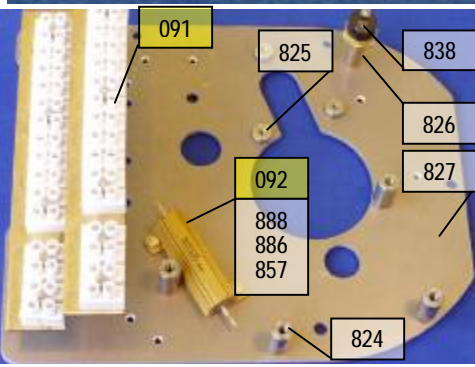
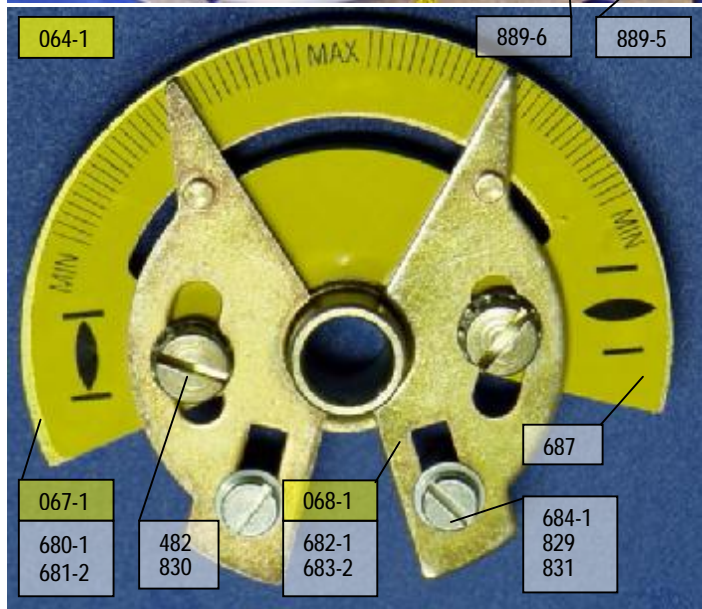

088 Otočná zdrž + Elektromotor ES 52 000

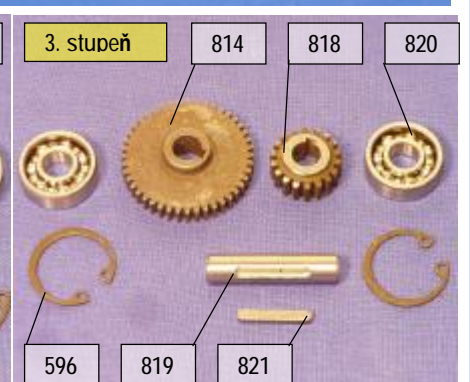
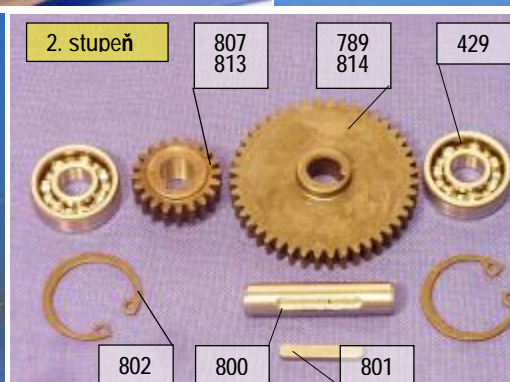
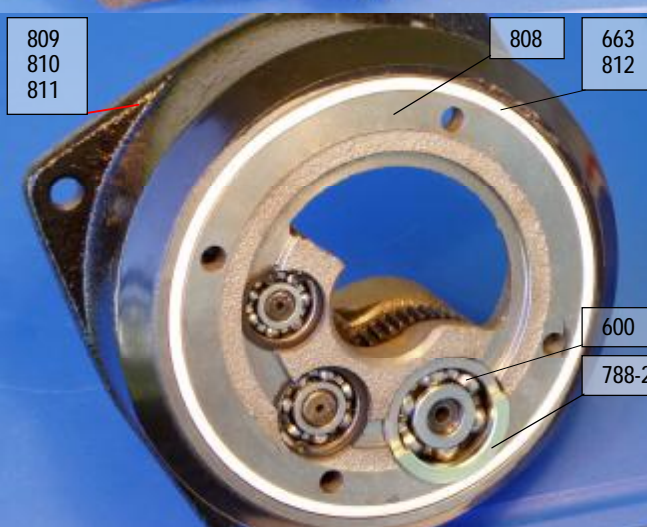
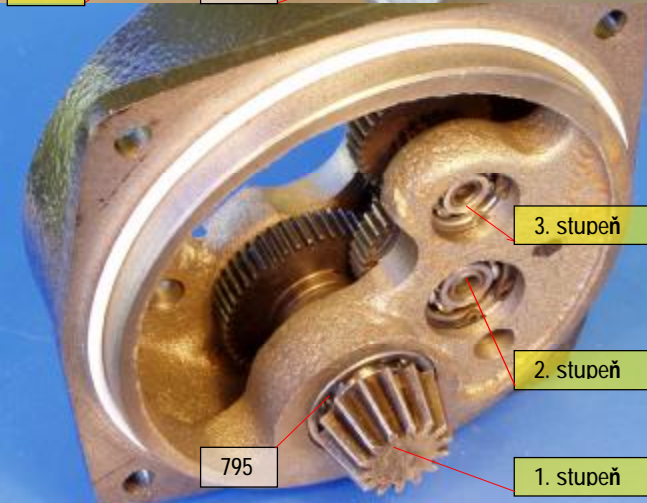
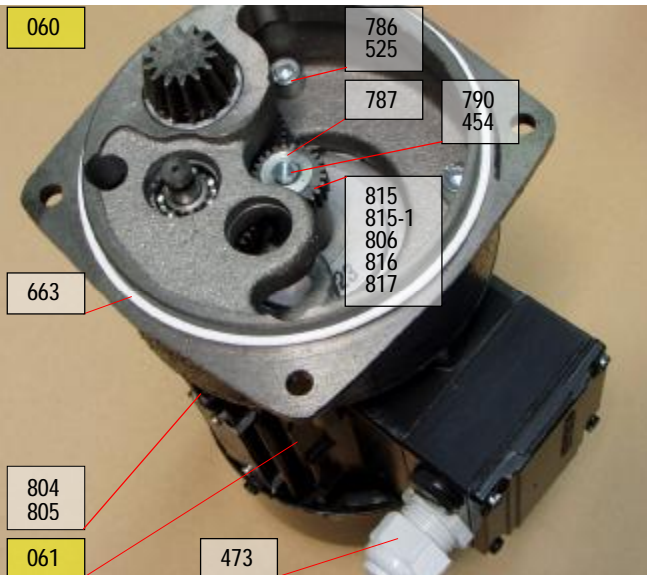

Poz.	Názov	PNm	Poznámky
088-XX	OTOČNÁ ZDRŽ + ELEKTROMOTOR	2245033XX	špec. textom
088-94	OTOČNÁ ZDRŽ + ELEKTROMOTOR	224503394	25 ot/min Rusko
060-72	OTOČNÁ ZDRŽ + ELEKTROMOTOR	224503772	R: 25 ot/min
060-XX	OTOČNÁ ZDRŽ + ELEKTROMOTOR	2245037XX	špec. textom
061-XX	MOTOR	2245096XX	špec. textom
061-64	MOTOR 380/220, 250W	224509664	pre RUSKO
429	LOŽISKO 6000	663243023	
473	VÝVODKA KÁBELOVÁ M 25X1,5	663457017	
525	PODLOŽKA FE 8-ZN	663111734	
663	KRUŽOK 125X3	662732115	pre MEDZIP.810
785	KOLESO OZUBENÉ	244515900	R: 25 ot/min
786	SKRUTKA FE MBX25-ZN-8.8	663111395	
787	PODLOŽKA	244516300	
788	PODLOŽKA	244515100	
789	KOLESO OZUBENÉ	244516600	
790	SKRUTKA FE M5X18-ZN	663111213	
791	PASTOROK KUŽELOVÝ	244515000	
792	PERO 4X4X16	663152056	
793	KRUŽOK	244515200	
794	VYRAŽAČ	244515300	
795	LOŽISKO 6300	663249039	
796	KLUČ	224515400	
797	VALCEK	224515500	
798	PRUŽINA	224515600	
799	PUZDRO PRUŽINY	224515700	
800	ČAP	224516900	
801	PERO 3X3X28	663152069	
802	KRUŽOK POISTNY FE 26	663111773	
803	KOLESO OZUBENÉ	244515800	R: 10,16,63 ot/min
804	PODLOŽKA D 10/D 6,2	204954302	od upev.sk.prír. M
805-27	MOTOR 1LA7070-4AB93-Z,380/220,250W	663592427	pre RUSKO
805-XX	MOTOR (typ, napätie, výkon špecifikovať text.)	XXXXXXXXX	špec. textom
806	PASTOROK	244946200	25 ot/min
807	PASTOROK	244516800	re 16,25,40 ot/min
808	TESNENIE (nezobrazené)	604964700	pre MEDZIP.811
809-X	MEDZIPRIRUBA	24451460X	re 16,25 ot/min
810-X	MEDZIPRIRUBA	24451470X	re 10,16 ot/min
811-10	MEDZIPRIRUBA-PLOCHE TESNENIE (nezobraze)	244514710	pre RUSKO
812	KRUŽOK 3167 110X3 MVO	662732128	pre MEDZIP.809
813	PASTOROK	244518000	R: 10,16 ot/min
814	KOLESO OZUBENÉ	244516700	40 ot/min
815-X	PASTOROK 815-1 pre R:16 ot/mi	24451830X	10 ot/min
816	PASTOROK	244931600	40 ot/min
817	PASTOROK	244514800	63 ot/min
818	PASTOROK	244518100	
819	ČAP	244518200	
820	LOŽISKO 608	663243030	
821	PERO	204966901	

090 Krokovo – polohová jednotka

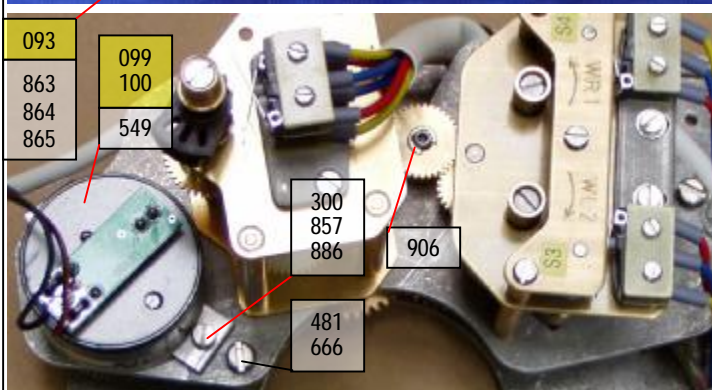
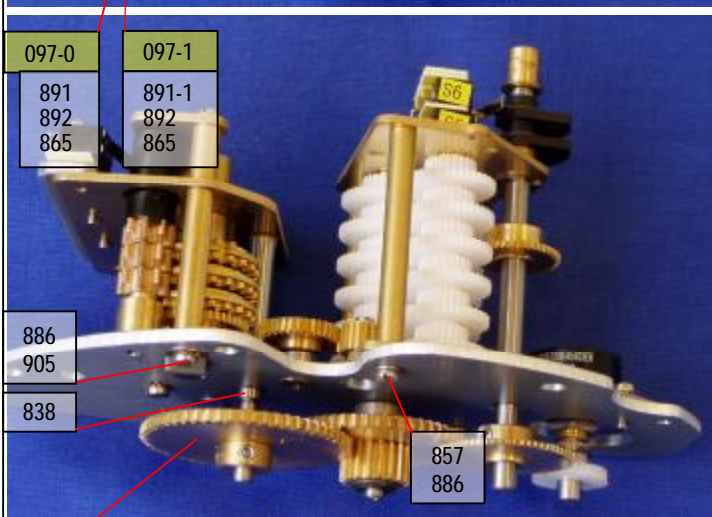
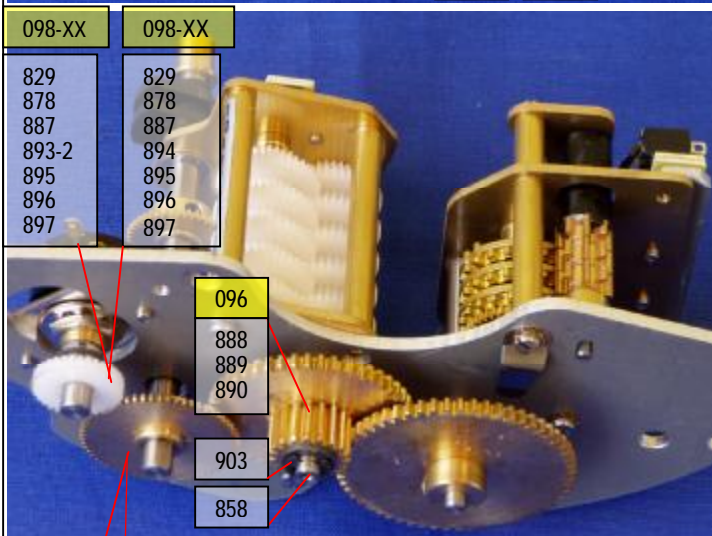
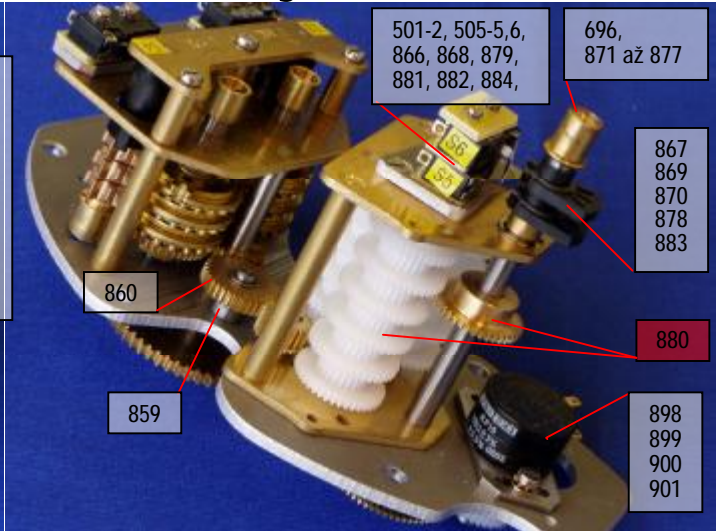
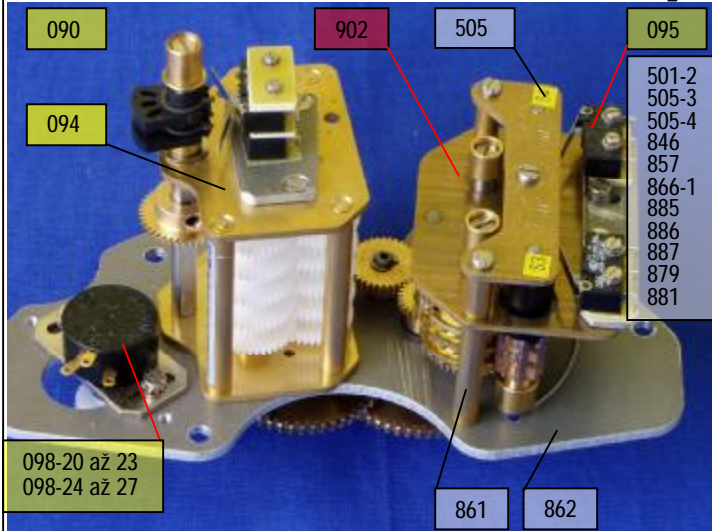

Poz	Názov	PNm	Poznámky
090	KJ-PJ MO ZOSTAVA	224A54100	
093	KOLESO NAHONU KJ	224A38100	
094	PJ ZOSTAVA	224A38500	
095	MSP DB6 KJ	224A39600	
096-1	DVOJKOLESO VLOZNE	224A39701	
097-X	KOLESO NAHONU VYSIEL. 097-0 RP 19	224A3820X	097-1 Náhon vys. CPT
098-20	VYSIELAČ ODPOROVÝ RP 19 1x100 Ohm	224A40820	098-24 až 27 s elektronikou
099	VYSIELAČ KAPACITNÝ	224A40900	
100	KOLESO S NABOJOM CPT	224A38000	Pre CPT vysieláč
481	SKRUTKA FE M 4X12-A2	663117735	
501-2	PODLOZKA	204703602	
505-X	STITOK OZNAC. MSP	604680900	505-3,4,5,6
549	VYSIELAČ KAPACITNÝ CPT 1/AV	664051781	
552	PRICHYTKA	244949400	
666	PODLOZKA M 4-A2	663117451	
696	PODLOZKA 3,2 A2	663118600	
846	SKRUTKA MS M2X12	663118008	
857	SKRUTKA MS M3X8	663118099	
858	ČAP 1	204A64801	
859	ČAP 2	204A64900	
860	MEDZIKOLESO Z 35 m=0,5	204A65800	
861	STLPIK KJ	204A65800	
862	DOSKA KJ-PJ	204B09500	
863	KOLESO NAHONU 1 KJ	204A66700	
864	NABOJ KOLESA	204A66700	
865	SKRUTKA FE M4X4-A2-70	663117260	
866-1	IZOLAČNA PODLOŽKA	204608701	
867	VÁČKA 65	604833500	
868	DRŽIAK SPINAČOV PJ DB6	204A68500	
869	HRIADEL' UKAZOVATEĽA PJ	204A68700	
870	KRUŽOK VYMEDZOVACI	204A68800	
871	UKAZOVATEĽ	224739600	
872	UKAZOVATEĽ POLOHY	604710400	
873	KOTUČ UKAZOVATEĽA	204771200	
874	STITOK	604771000	
875	KRUŽOK 5x1,8	662732176	
876	SKRUTKA ST 2,9X9,5-A2	663117125	
877	KRUŽOK POISTNÝ 11	663112876	
878	KRUŽOK 8-A2	663117677	
879	MIKROSPINAC DB 6G A1LB	664051466	
880	REDUKČNA PREVODOVKA DREHMO	663592101	
881	PODLOŽKA 2,2-A2	663117460	
882	SKRUTKA M2X20-A2-70	663117006	
883	SKRUTKA MS M3X8	663118643	
884	SKRUTKA M3X6-A2-70	663117780	
885	DRŽIAK SPINAČOV KJ DB6	204A68600	
886	PODLOŽKA FE M3-A2	663117450	
887	PODLOŽKA FE M3,2	663117390	
888	KOLESO VLOZENE 2	204A66200	
889	KOLESO VLOZENE 48Z/0,8	204B09400	
890	PUZDRO GFM-0507-05	663452194	
891-X	KOLESO NAHONU VYSIE. 891-0 RP 19	204A6600X	891-1 CPT 1
892	NABOJ KOLESA	204A70500	
893-2	KOLESO	204774202	
894	KOLESO (PRE ELEKTRONIKU)	204730300	S elektronikou
895	KRUŽOK VYSIELAČA	204940300	
896	DRŽIAK ODPOROVEHO VYSIELAČA	204A65300	
897	PODLOŽKA 3,2	663118623	
898	VYSIELAČ RP 19 1X100 Ohm	664051812	
899	VYSIELAČ RP 19 2X100 Ohm	664051814	
900	VYSIELAČ RP 19 1X2000 Ohm	664051827	
901	VYSIELAČ RP 19 2X2000 Ohm	664051825	
902	KROKOVA PREVODOVKA DREHMO	663592100	
903	KRUŽOK FE 3,2-A2	663117650	
904	PUZDRO GFM-0608-04	663452211	
905	SKRUTKA M3X10-A2-70	663117009	
906	KRUŽOK FE 4	663117651	