



BUILDING FEATURES / CARATTERISTICHE COSTRUTTIVE

Series **K** mini-valves and solenoid valves are built in compact dimensions and are capable to be assembled on manifolds. In order to assure their performance, particular care and attention have been offered in developing each component for this product.

Possibility to operate continuously without lubrication (**A**).

The spool is manufactured in a light alloy (**B**).

This offers lasting durability and a high working frequency (**E**) : due to the manufacturing of the internal moving parts, inertia and friction are greatly reduced, and a better resistance to the external aggressive agents is assured by the nickel treatment (**C**).

The nominal air flow of the valve is around 730, 1300, 4000 NI/min (**D**), despite of its small dimensions.

The solenoid valves, complete with coil and connector, follows EEC directives on the electromagnetic compatibility (89/336/EEC) and low voltage (73/23/EEC).

*Le mini valvole ed elettrovalvole Vesta serie **K** funzionano secondo il principio del cassetto bilanciato (vedi fig. 1e 2), presentano ingombri molto ridotti e la possibilità di assemblaggio in batterie compatte.*

*Particolare cura è stata prestata nella progettazione e realizzazione di ogni singolo componente del prodotto, al fine di consentire elevate prestazioni funzionali. Caratteristiche comuni a tutte le valvole della serie sono l'alta velocità di scambio (**E**), la possibilità di funzionamento continuo privo di lubrificazione (**A**) ottenuto con l'impiego di materiali particolari come, ad esempio, la spola, realizzata in lega leggera (**B**), ed il corpo, in alluminio trattato al nichel (**C**). Tutto ciò garantisce una elevata frequenza di lavoro e una lunga vita del sistema, grazie ad una riduzione dell'inerzia delle parti mobili, ad una riduzione degli attriti interni e ad un maggior grado di resistenza agli agenti aggressivi esterni. Particolarmente interessante, nonostante le ridotte dimensioni, la portata nominale: 730, 1300, 4000 NI/min. (**D**).*

Le elettrovalvole complete di bobina e connettore, sono conformi alle direttive CEE relative alla compatibilità elettromagnetica (89/336/CEE) ed alla bassa tensione (73/23/CEE).

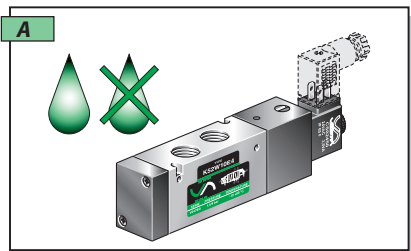

Possibility to operate continuously without lubrication.

Possibilità di funzionamento continuo privo di lubrificazione.

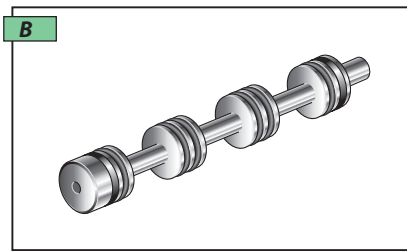

Light alloy spool.

Spola in lega leggera.

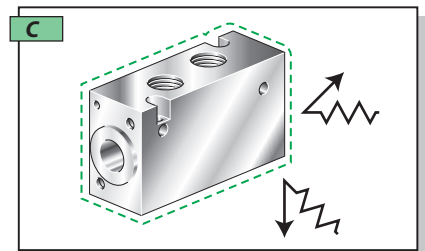

Nickel treated body.

Corpo in alluminio trattato al nichel.

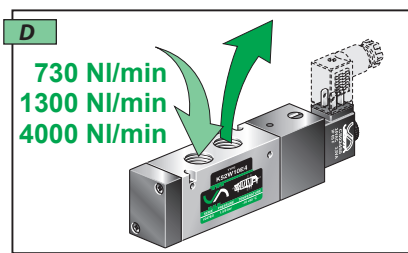

Nominal air flow: (730, 1300, 4000 NI/min).

Alta portata nominale: (730, 1300, 4000 NI/min a 6 bar).

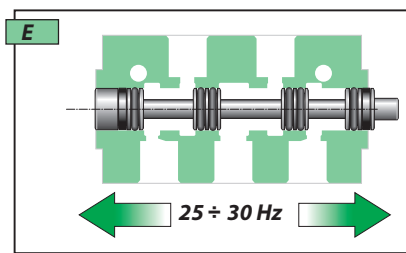

High working frequency.

Alta velocità di scambio.

WORKING PRINCIPLE / PRINCIPIO DI FUNZIONAMENTO

In the example here below (**K52W1018-02450** - 5/2 valve, single solenoid, spring return), when the valve stands in the normal position, ports **4 - 5** and **1 - 2** are connected and the position is kept thanks to the pressure assured to the smallest piston and to the spring force (right side of the valve). When the valve is actuated, the same pressure is fed to the biggest piston. Its bigger surface create a force which allows to the spool to move and therefore to connect ports **4 - 1** and **2 - 3**. Spring return assures (grant) the normal position of the spool even if no pressure is brought to the valve.
In the bistable versions, the position of the valve remains in its last switched state.

*Il principio di funzionamento del distributore 5/2 (nell'esempio l'elettrovalvola **K52W1018-02450** con comando elettropneumatico e riposizionamento a molla) consiste nel mantenere la spola in posizione di riposo per azione sia di una molla meccanica che per effetto della pressione creata dalla fonte d'aria compressa presente nel condotto di alimentazione **1** sulla spola stessa (fig. **1**) collegando le vie **1- 2** e **4 - 5**.*

*L'eccitazione del solenoide mette in comunicazione il condotto **1** con la camera dove è alloggiato il pistone di comando. Quest'ultimo contrasta l'insieme delle forze create dalla molla e dalla pressione sul lato opposto della spola, spostandola in modo tale da collegare i canali **1- 4** e **2- 3** (fig. **2**).*

Diseccitando il solenoide si ripristina la posizione iniziale. La combinazione del sistema a molla meccanica con il riposizionamento pneumatico consente di avere sempre la spola in posizione di riposo anche dopo la caduta di pressione del sistema.

Nei sistemi bistabili (doppio comando elettropneumatico o doppio comando pneumatico) in assenza di segnale rimangono i collegamenti formatisi nell'ultimo azionamento.

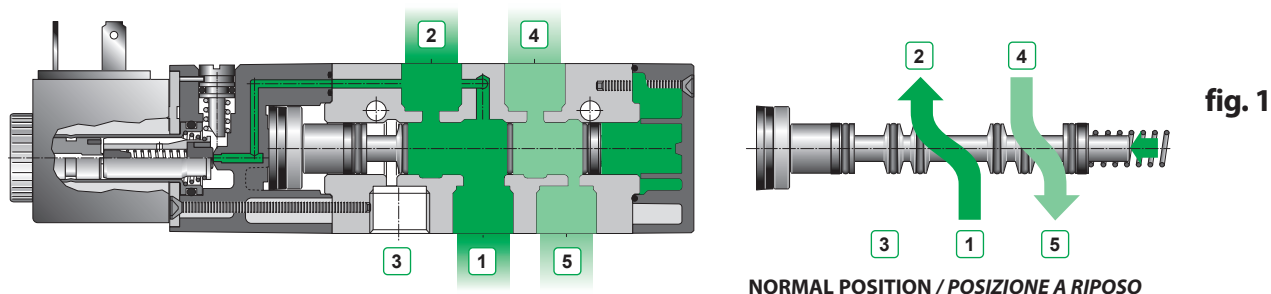

NORMAL POSITION / POSIZIONE A RIPOSO

fig. 1

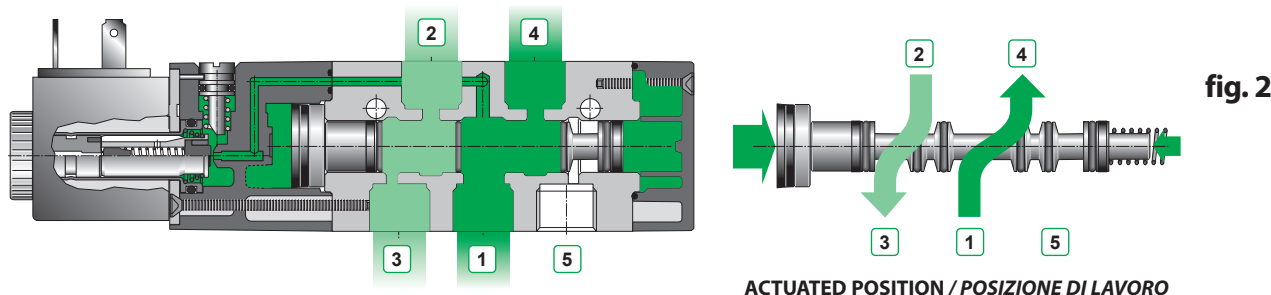

ACTUATED POSITION / POSIZIONE DI LAVORO

fig. 2

MANUAL OVERRIDING / AZIONAMENTO COMANDO MANUALE

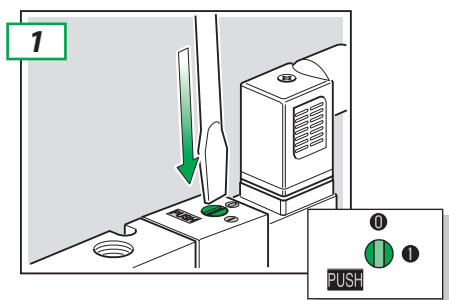

Push to actuated valve without locking. **Relise the button to get back to normal position.**

*Per azionare la valvola, durante la fase di collaudo con pressione in linea senza collegamento elettrico, usare un adeguato cacciavite per premere la vite del comando manuale. **Rilasciare per ripristinare la condizione di riposo.***

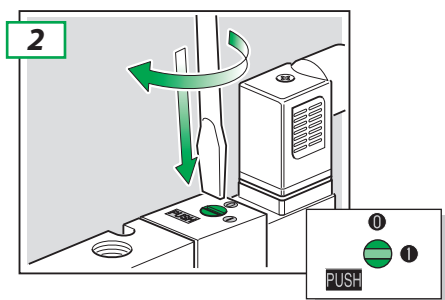

To active the valve permanently, push the M/O using a screwdriver and rotate clockwise 90°.

Per azionare la valvola in modo permanente premere la vite del comando manuale e ruotare in senso orario sino alla posizione 1.

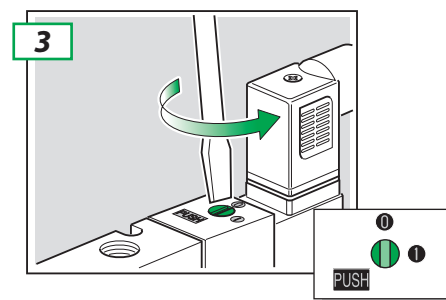

To get back to normal position push the M/O again and turn 90° anti-clockwise.

Ruotare in senso antiorario la vite del comando manuale per ripristinare la condizione di riposo.



MINI VALVES AND MINI SOLENOID VALVES SERIES "K" / MINI VALVOLE E MINI ELETTROVALVOLE SERIE "K" G1/4-G1/2

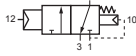

K32P161.

SINGLE PNEUMATIC PILOT - INTERNAL PRESSURE RETURN
COMANDO PNEUMATICO - RIT. MOLLA MECCANICA E PNEUMATICA

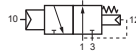

K32P191.

SINGLE PNEUMATIC PILOT - INTERNAL PRESSURE RETURN
COMANDO PNEUMATICO - RIT. MOLLA MECCANICA E PNEUMATICA

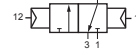

K32P201.

DOUBLE PNEUMATIC PILOT
DOPPIO COMANDO PNEUMATICO



K52P101.

SINGLE PNEUMATIC PILOT - INTERNAL PRESSURE RETURN
COMANDO PNEUMATICO - RIT. MOLLA MECCANICA E PNEUMATICA

pag. B-43

pag. B-44

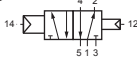

K52DP214

DOUBLE DIFFERENTIAL PNEUMATIC PILOT
DOPPIO COMANDO PNEUMATICO DIFFERENZIALE

pag. B-44

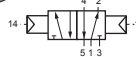

K52P201.

DOUBLE PNEUMATIC PILOT
DOPPIO COMANDO PNEUMATICO

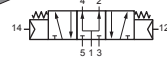

K53P231.

DOUBLE PNEUMATIC PILOT (MID-POSITION PRESSURIZED)
DOPPIO COMANDO PNEUMATICO (CENTRI IN PRESSIONE)

pag. B-45

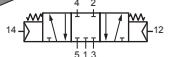

K53P261.

DOUBLE PNEUMATIC PILOT (MID-POSITION CLOSED)
DOPPIO COMANDO PNEUMATICO (CENTRI CHIUSI)

pag. B-45

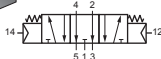

K53P291.

DOUBLE PNEUMATIC PILOT (MID-POSITION EXHAUSTED)
DOPPIO COMANDO PNEUMATICO (CENTRI APERTI)

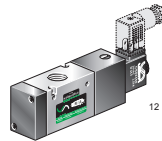

K32W1S61.

SINGLE SOLENOID PILOT - INTERNAL PRESSURE RETURN
COMANDO ELETTROPNEUMATICO - RIPOSIZIONAMENTO A MOLLA

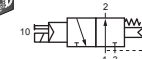

K32W1S91.

SINGLE SOLENOID PILOT - INTERNAL PRESSURE RETURN
COMANDO ELETTROPNEUMATICO - RIPOSIZIONAMENTO A MOLLA

pag. B-46

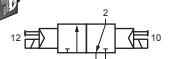
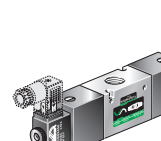

K32W2S01.

DOUBLE SOLENOID PILOT
DOPPIO COMANDO ELETTROPNEUMATICO

pag. B-47

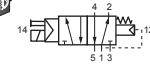
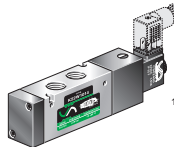

K52W101.

SINGLE SOLENOID PILOT - INTERNAL PRESSURE RETURN
COMANDO ELETTROPNEUMATICO - RIPOSIZIONAMENTO A MOLLA

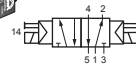
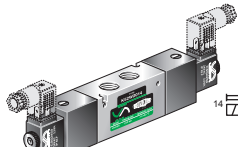

K52W201.

DOUBLE SOLENOID PILOT
DOPPIO COMANDO ELETTROPNEUMATICO

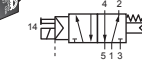
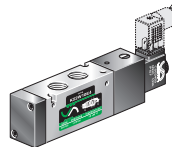

K52W10E.

SINGLE SOLENOID PILOT - EXTERNAL PRESSURE RETURN
COMANDO ELETTROPNEUMATICO - PILOTAGGIO ESTERNO

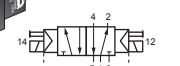
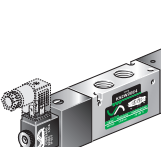

K52W20E.

DOUBLE SOLENOID PILOT - EXTERNAL PRESSURE RETURN
DOPPIO COMANDO ELETTROPNEUM. - PILOTAGGIO ESTERNO

pag. B-48

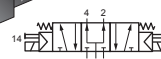
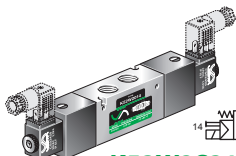

K53W2S31.

DOUBLE SOLENOID PILOT (MID-POSITION PRESSURIZED)
DOPPIO COMANDO ELETTROPNEUM. (CENTRI IN PRESSIONE)

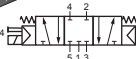
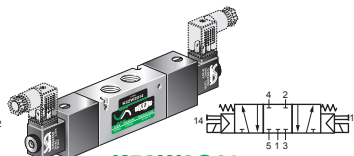

K53W2S61.

DOUBLE SOLENOID PILOT (MID-POSITION CLOSED)
DOPPIO COMANDO ELETTROPNEUMATICO (CENTRI CHIUSI)

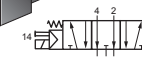
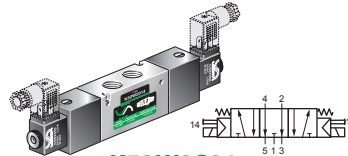

K53W2S91.

DOUBLE SOLENOID PILOT (MID-POSITION EXHAUSTED)
DOPPIO COMANDO ELETTROPNEUMATICO (CENTRI APERTI)

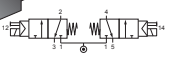
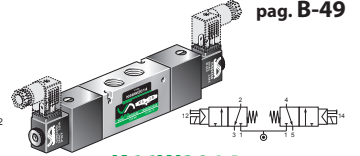

K66W2014

DOUBLE 3/2 N.C. SPRING RETURN VALVE
DOPPIA VALVOLA 3/2 N.C. RITORNO A MOLLA MECCANICA

pag. B-49

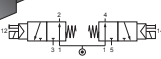
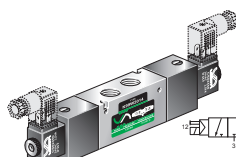

K99W2014

DOUBLE 3/2 N.O. SPRING RETURN VALVE
DOPPIA VALVOLA 3/2 N.O. RITORNO A MOLLA MECCANICA

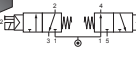
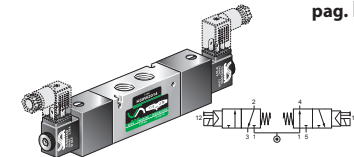

K69W2014

3/2 N.C. + 3/2 N.O. VALVES SPRING RETURN
VALVOLA 3/2 N.C. + VALVOLA 3/2 N.O. RITORNO A MOLLA MECCANICA

pag. B-50

pag. B-51



KME.14

ENBLOC TILL 10 SIZES MAX
BASE DOPPIO INGRESSO FINO A 10 POSTI

ACCESSORIES / ACCESSORI

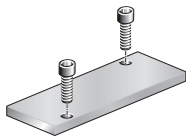

pag. B-52

KPCH0..

PLUG FLAT
CHIUSURA POSTO INUTILIZZATO



CS.....

COILS
SOLENOIDI PER ELETTROVALVOLE

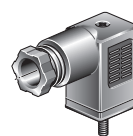

pag. B-52

CEP/0... ..

SOLENOID CONNECTORS
CONNETTORI

SERIE K
TECHNICAL FEATURES / CARATTERISTICHE TECNICHE
COMMON TECHNICAL FEATURES K SERIE / CARATTERISTICHE TECNICHE COMUNI SERIE K

Port connections	G1/8, G1/4	Connessioni di lavoro	G1/8, G1/4
Flow section	G1/8" = Ø 6 mm	Diametro nominale	G1/8" = Ø 6 mm
	G1/4" = Ø 8 mm		G1/4" = Ø 8 mm
	G1/2" = Ø 14 mm		G1/2" = Ø 14 mm
Environment temperature range	-10 °C ÷ +50 °C	Temperatura ambiente	-10 °C ÷ +50 °C
Temperature range of medium	0 °C ÷ +40 °C	Temperatura fluido	0 °C ÷ +40 °C
Lubrication	Not required	Lubrificazione	Non necessaria
Medium	Filtered air	Fluido	Aria filtrata
Reference pressure	6 bar	Pressione nominale	6 bar
Nominal air flow 3/2 and 5/2 valves (valves 5/3)	G1/8" : 730 (552) NI/min	Portata nominale valvole 3/2 e 5/2 (valvole 5/3)	G1/8" : 730 (552) NI/min
	G1/4" : 1300 (1040) NI/min		G1/4" : 1300 (1040) NI/min
	G1/2" : 4000 (3500) NI/min		G1/2" : 4000 (3500) NI/min

PNEUMATIC VALVES FEATURES / CARATTERISTICHE VALVOLE PNEUMATICHE

G 1/2"		K32P1612	K32P1912	K32P2012	K52P1012	-	K52P2012	K53P2312	K53P2612	K53P2912
	Nominal pilot pressure (bar) <i>Pressione di pilotaggio nominale (bar)</i>	3,1 bar (9 bar)	3,1 bar (9 bar)	0,97 ba ^r	3,1 bar (9 bar)	-	0,97 bar	3 bar	3 bar	3 bar
	Nominal max frequency (Hz) <i>Frequenza max nominale (Hz)</i>	15 Hz	15 Hz	18 Hz	15 Hz	-	18 Hz	10 Hz	10 Hz	10 Hz
	Operating pressure range (bar) <i>Pressione di esercizio (bar)</i>	2,5 ÷ 9 bar	2,5 ÷ 9 bar	0 ÷ 9 bar	2,5 ÷ 9 bar	-	0 ÷ 9 bar	0 ÷ 9 bar	0 ÷ 9 bar	0 ÷ 9 bar

SOLENOID VALVES FEATURES / CARATTERISTICHE ELETTROVALVOLE

G 1/2"		K32W1S612	K32W1912	K32W2S012	K52W1012	K52W2012	K52W10E2	K52W20E2	K53W2S312	K53W2S612	K53W2S912
	Nominal max frequency (Hz) <i>Frequenza max nominale (Hz)</i>	13Hz AC 11Hz DC	13Hz AC 11Hz DC	17Hz AC 16Hz DC	13Hz AC 11Hz DC	17Hz AC 16Hz DC	13Hz AC 11Hz DC	17Hz AC 16Hz DC	13Hz AC 8Hz DC	13Hz AC 8Hz DC	13Hz AC 8Hz DC
	Operating pressure range (bar) <i>Pressione di esercizio (bar)</i>	2,5÷9 bar	2,5÷9 bar	1,5÷9 bar	2,5÷9 bar	1,5÷9 bar	0÷9 bar	0÷9 bar	3÷9 bar	3÷9 bar	3÷9 bar
	External pilot port <i>Connessione di pilotaggio esterna</i>	-	-	-	-	-	M5	M5	-	-	-
	Pilot pressure <i>Pressione di pilotaggio</i>	-	-	-	-	-	3÷9 bar	3÷9 bar	-	-	-



K32W1S.1.

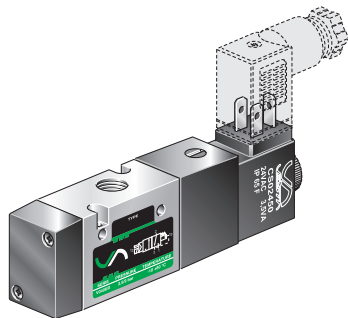

SIMBOLS / SIMBOLI

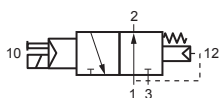

**K32W1S918 - K32W1S914
K32W1S912**

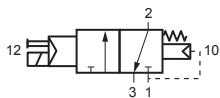

**K32W1S618 - K32W1S614
K32W1S612**

DIAGRAMS / DIAGRAMMI

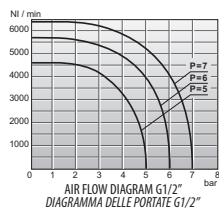
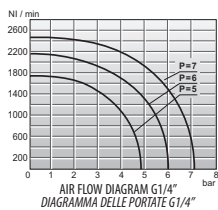
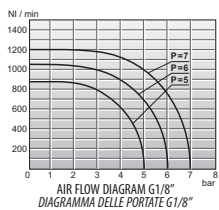

VALVE / 3/2

SINGLE SOLENOID PILOT - INTERNAL PRESSURE RETURN AND SPRING
COMANDO ELETTROPNEUMATICO - RIPOSIZIONAMENTO A MOLLA PNEUMATICA E MECCANICA

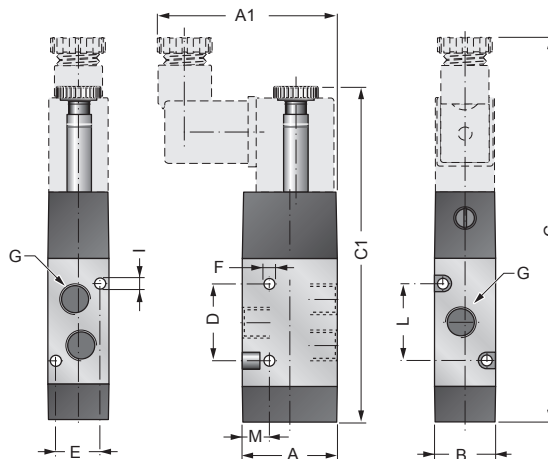

Size Taglia	A	A1	B	C	C1	D	E	ØF	G	ØI	L	M
1/8	28	~53	18	112,5	~99	22,2	13	3,2	G1/8	3,2	22,2	8
1/4	32	~55	22	121	~107,5	29,3	16,2	4,2	G1/4	3,5	29,3	7,3
1/2	50	~75	30	~150	~137	45,6	-	5,2	G1/2	-	-	11

K32W2S01.

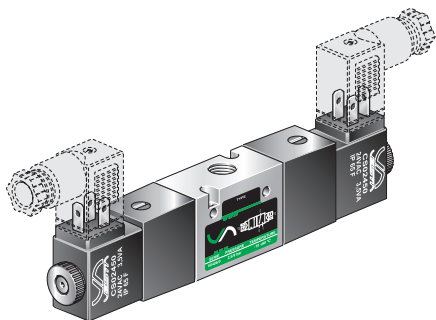

SIMBOLS / SIMBOLI

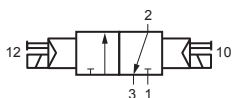

K32W2S018 - K32W2S014 - K32W2S012

DIAGRAMS / DIAGRAMMI

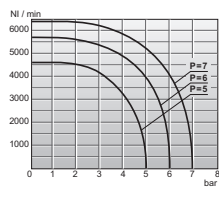
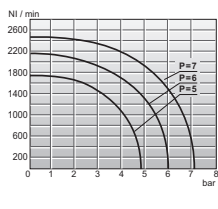
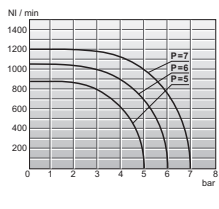

VALVE / VALVOLA 3/2

DOUBLE SOLENOID PILOT / DOPPIO COMANDO ELETTROPNEUMATICO

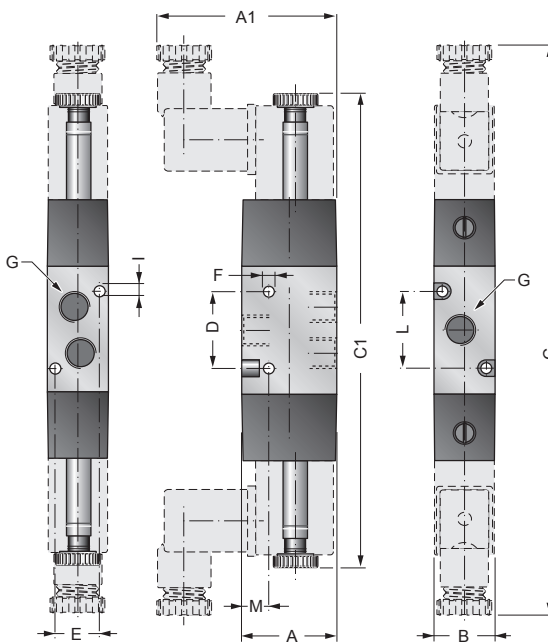

Size Taglia	A	A1	B	C	C1	D	E	ØF	G	ØI	L	M
1/8	28	~53	18	170	~143	22,2	13	3,2	G1/8	3,2	22,2	8
1/4	32	~55	22	181	~154	29,3	16,2	4,2	G1/4	3,5	29,3	7,3
1/2	50	~75	30	~210	~180	45,6	-	5,2	G1/2	-	-	11

VALVE / VALVOLA 5/2

SINGLE SOLENOID PILOT - INTERNAL PRESSURE RETURN AND SPRING
 COMANDO ELETTROPNEUMATICO - RIPOSIZIONAMENTO A MOLLA PNEUMATICA E MECCANICA

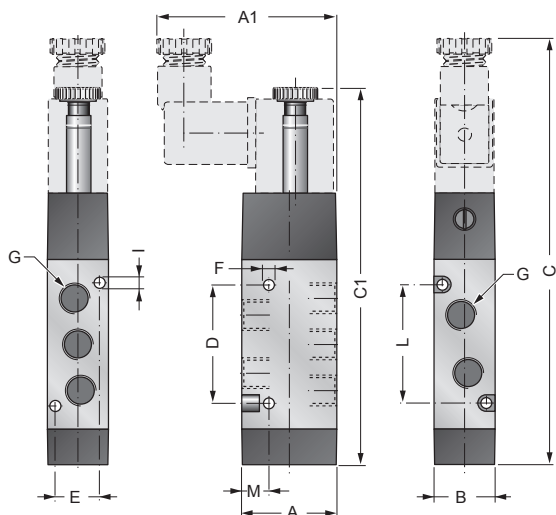

Size Taglia	A	A1	B	C	C1	D	E	ØF	G	ØI	L	M
1/8	28	~53	18	~125,5	112	35	13	3,2	G1/8	3,2	35	8
1/4	32	~55	22	142,5	~129	50	16,2	4,2	G1/4	3,5	50	7,3
1/2	50	~75	30	~180	~166	46	-	5,2	G1/2	-	-	11

K52W101.

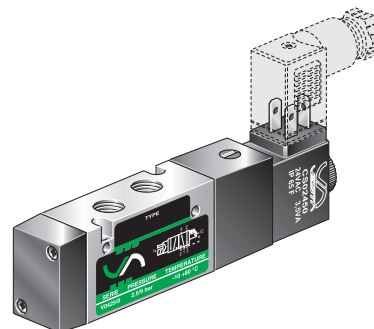

SIMBOLS / SIMBOLI

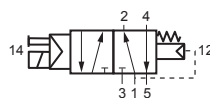

K52W1018

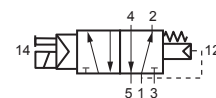

K52W1014 - K52W1012

DIAGRAMS / DIAGRAMMI

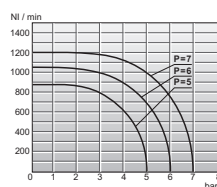

AIR FLOW DIAGRAM G1/8"
 DIAGRAMMA DELLE PORTATE G1/8"

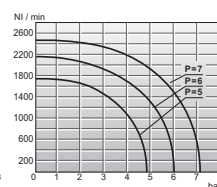

AIR FLOW DIAGRAM G1/4"
 DIAGRAMMA DELLE PORTATE G1/4"

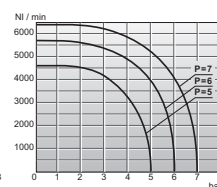

AIR FLOW DIAGRAM G1/2"
 DIAGRAMMA DELLE PORTATE G1/2"

VALVE / 5/2

DOUBLE SOLENOID PILOT / DOPPIO COMANDO ELETTROPNEUMATICO

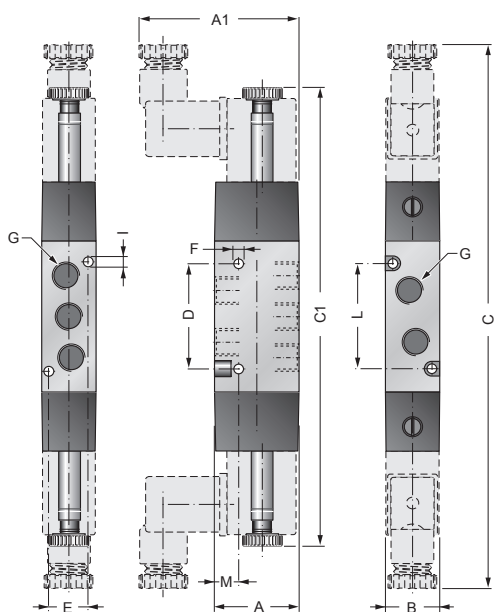

Size Taglia	A	A1	B	C	C1	D	E	ØF	G	ØI	L	M
1/8	28	~53	18	180	~152	35	13	3,2	G1/8	3,2	35	8
1/4	32	~55	22	202	~174	50	16,2	4,2	G1/4	3,5	50	7,3
1/2	50	~75	30	~240	~210	45,6	-	5,2	G1/2	-	-	11

K52W201.

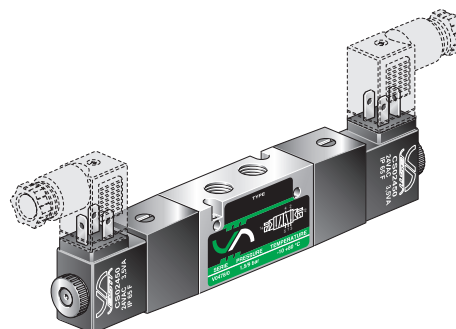

SIMBOLS / SIMBOLI

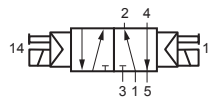

K52W2018

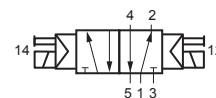

K52W2014 - K52W2012

DIAGRAMS / DIAGRAMMI

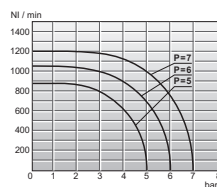

AIR FLOW DIAGRAM G1/8"
 DIAGRAMMA DELLE PORTATE G1/8"

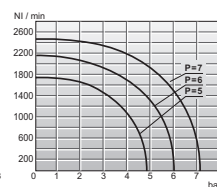

AIR FLOW DIAGRAM G1/4"
 DIAGRAMMA DELLE PORTATE G1/4"

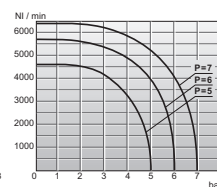

AIR FLOW DIAGRAM G1/2"
 DIAGRAMMA DELLE PORTATE G1/2"



K52W10E.

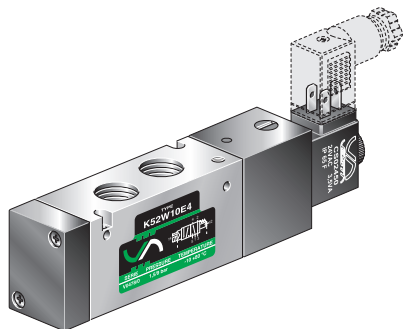

SIMBOLS / SIMBOLI

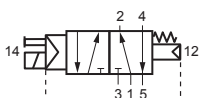

K52W10E8

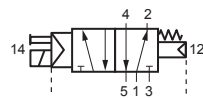

K52W10E4 - K52W10E2

DIAGRAMS / DIAGRAMMI

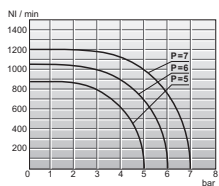

AIR FLOW DIAGRAM G1/8"
DIAGRAMMA DELLE PORTATE G1/8"

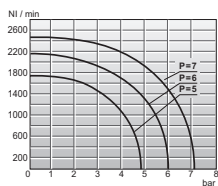

AIR FLOW DIAGRAM G1/4"
DIAGRAMMA DELLE PORTATE G1/4"

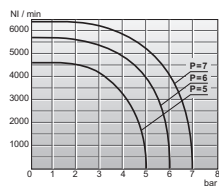

AIR FLOW DIAGRAM G1/2"
DIAGRAMMA DELLE PORTATE G1/2"

VALVE / 5/2 SINGLE SOLENOID PILOT - EXTERNAL PRESSURE RETURN COMANDO ELETTROPNEUMATICO - PILOTAGGIO ESTERNO

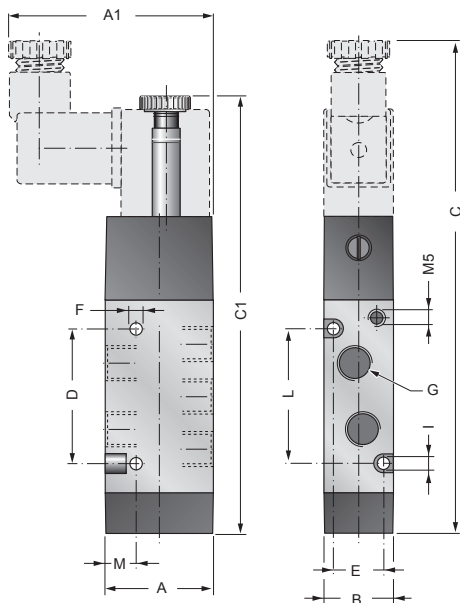

Size Taglia	A	B	C	D	E	ØF	G	ØI	L	M	A1	C1
1/8	28	18	127	35	13	3,2	G1/8	3,2	35	8	53	112
1/4	32	22	142,5	50	16,2	4,2	G1/4	3,5	50	7,3	55	129
1/2	50	30	~180	46	-	5,2	G1/2	-	-	11	~75	~166

K52W20E.

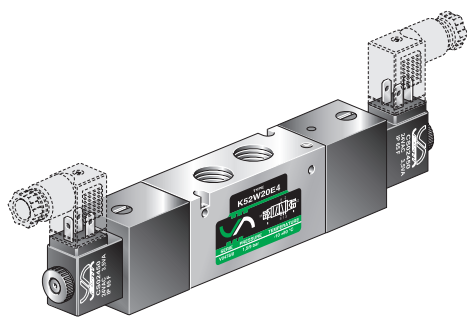

SIMBOLS / SIMBOLI

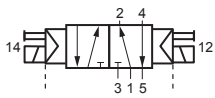

K52W20E8

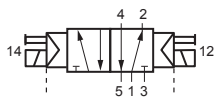

K52W20E4 - K52W20E2

DIAGRAMS / DIAGRAMMI

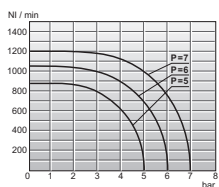

AIR FLOW DIAGRAM G1/8"
DIAGRAMMA DELLE PORTATE G1/8"

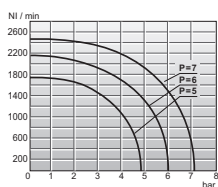

AIR FLOW DIAGRAM G1/4"
DIAGRAMMA DELLE PORTATE G1/4"

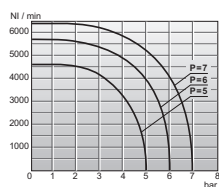

AIR FLOW DIAGRAM G1/2"
DIAGRAMMA DELLE PORTATE G1/2"

VALVE / VALVOLA 5/2 DOUBLE SOLENOID PILOT - EXTERNAL PRESSURE RETURN DOPPIO COMANDO ELETTROPNEUMATICO - PILOTAGGIO ESTERNO

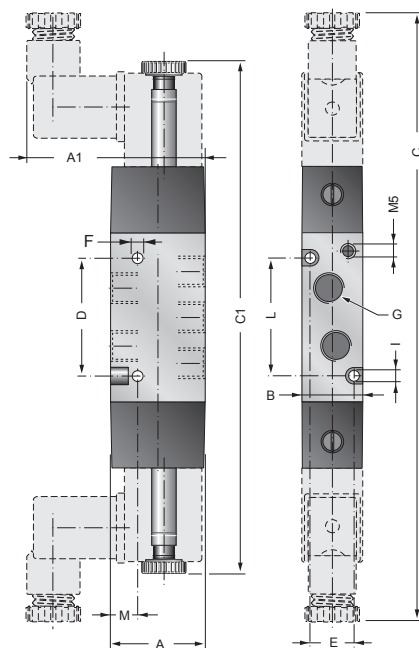

Size Taglia	A	B	C	D	E	ØF	G	ØI	L	M	A1	C1
1/8	28	18	180	35	13	3,2	G1/8	3,2	35	8	53	152
1/4	32	22	202	50	16,2	4,2	G1/4	3,5	50	7,3	55	174
1/2	50	30	~240	45,6	-	5,2	G1/2	-	-	11	~75	~210

VALVE / 5/3

DOUBLE PNEUMATIC PILOT (MID-POSITION PRESSURIZED) / **DOPPIO COMANDO PNEUMATICO (CENTRI IN PRESSIONE)**
 DOUBLE PNEUMATIC PILOT (MID-POSITION CLOSED) / **DOPPIO COMANDO PNEUMATICO (CENTRI CHIUSI)**
 DOUBLE PNEUMATIC PILOT (MID-POSITION EXHAUSTED) / **DOPPIO COMANDO PNEUMATICO (CENTRI APERTI)**

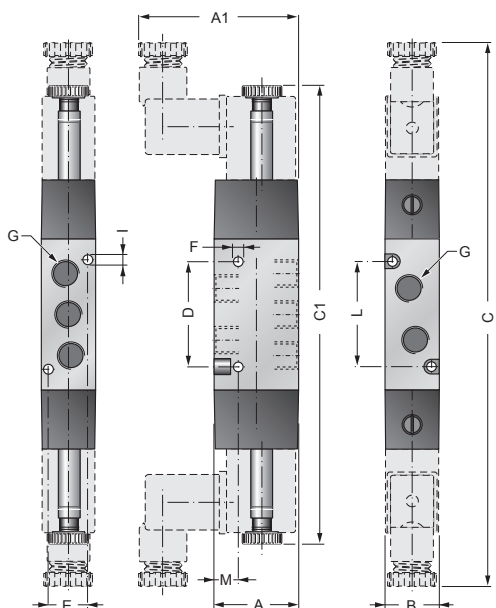

Size Taglia	A	A1	B	C	C1	D	E	ØF	G	ØI	L	M
1/8	28	~53	18	180	~152	35	13	3,2	G1/8	3,2	35	8
1/4	32	~55	22	202	~174	50	16,2	4,2	G1/4	3,5	50	7,3
1/2	50	~75	30	~240	~210	45,6	-	5,2	G1/2	-	-	11

K53W2S.1.

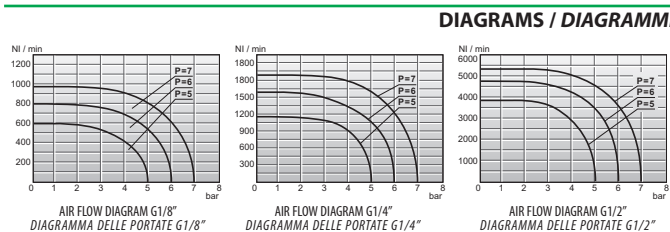
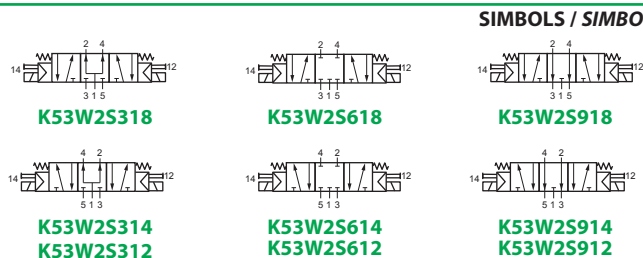
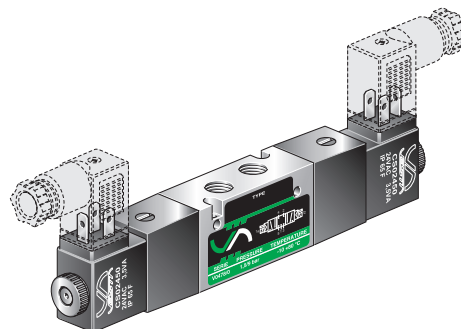

DOUBLE 3/2 VALVE / DOPPIA 3/2

DUBLE 3/2 N.C. SPRING RETURN VALVE
 DOPPIA VALVOLA 3/2 N.C. RITORNO A MOLLA MECCANICA

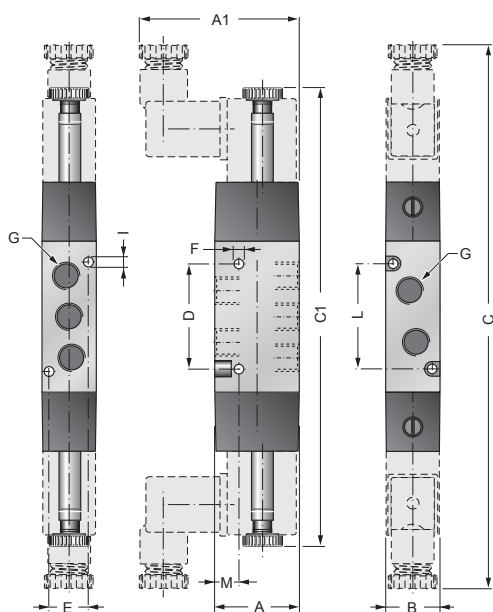

Size Taglia	A	A1	B	C	C1	D	E	ØF	G	ØI	L	M
1/8	28	~53	18	180	~152	35	13	3,2	G1/8	3,2	35	8
1/4	32	~55	22	202	~174	50	16,2	4,2	G1/4	3,5	50	7,3

K66W201.

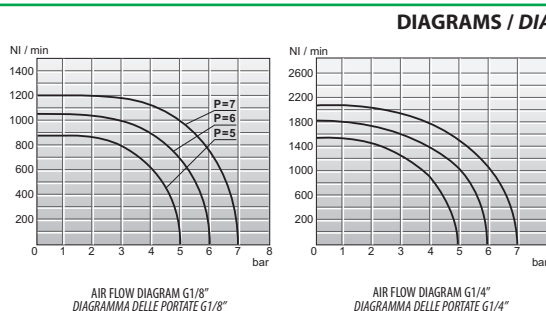
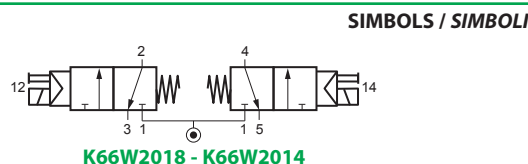
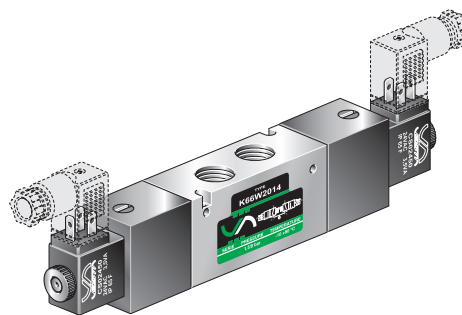



K99W201.

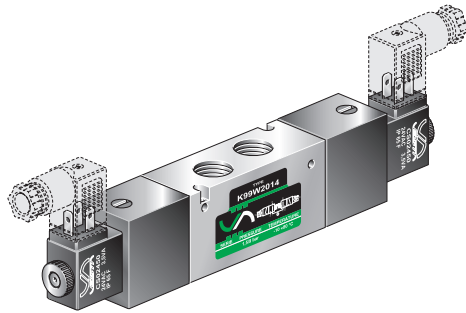

SIMBOLS / SIMBOLI

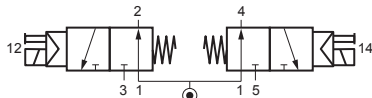

K99W2018 - K99W2014

DIAGRAMS / DIAGRAMMI

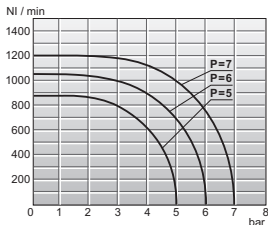

AIR FLOW DIAGRAM G1/8"
DIAGRAMMA DELLE PORTATE G1/8"

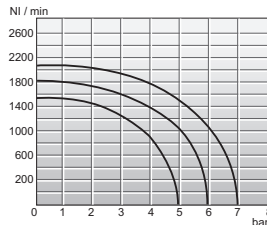

AIR FLOW DIAGRAM G1/4"
DIAGRAMMA DELLE PORTATE G1/4"

DOUBLE 3/2 VALVE / DOPPIA VALVOLA 3/2

DUBLE 3/2 N.O. SPRING RETURN VALVE
DOPPIA VALVOLA 3/2 N.O. RITORNO A MOLLA MECCANICA

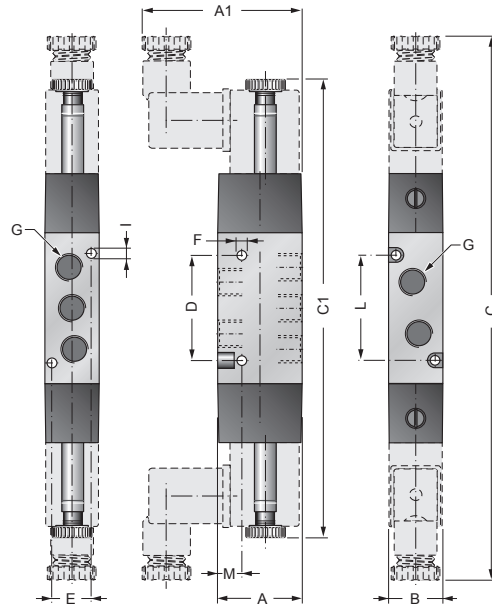

Size	A	A1	B	C	C1	D	E	ØF	G	ØI	L	M
1/8	28	~53	18	180	~152	35	13	3,2	G1/8	3,2	35	8
1/4	32	~55	22	202	~174	50	16,2	4,2	G1/4	3,5	50	7,3

K69W201.

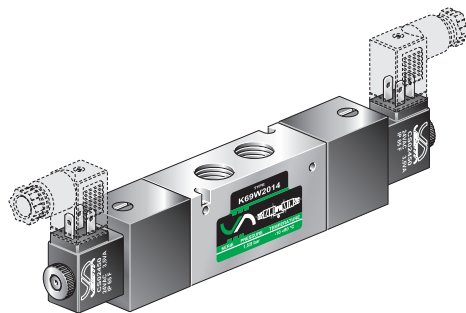

SIMBOLS / SIMBOLI

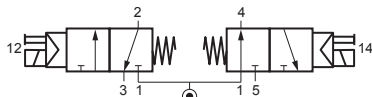

K69W2018 - K69W2014

DIAGRAMS / DIAGRAMMI

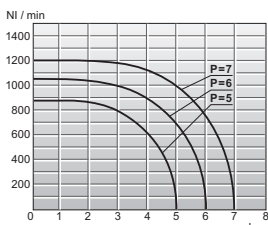

AIR FLOW DIAGRAM G1/8"
DIAGRAMMA DELLE PORTATE G1/8"

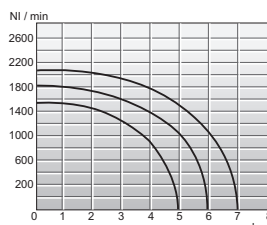

AIR FLOW DIAGRAM G1/4"
DIAGRAMMA DELLE PORTATE G1/4"

DOUBLE 3/2 VALVE / DOPPIA VALVOLA 3/2

3/2 N.C. + 3/2 N.O. VALVES SPRING RETURN
VALVOLA 3/2 N.C. + VALVOLA 3/2 N.O. RITORNO A MOLLA MECCANICA

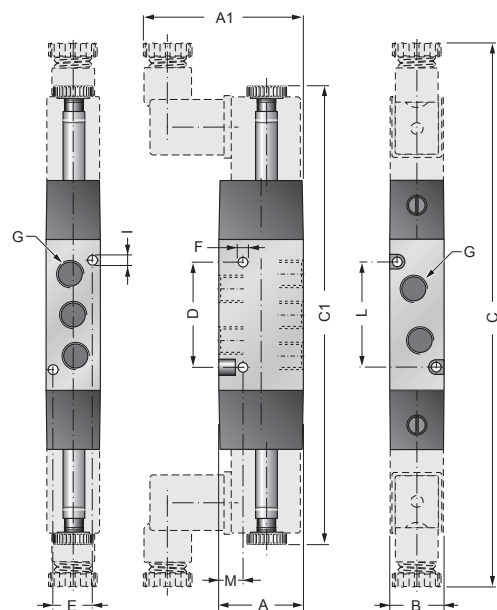

Size	A	A1	B	C	C1	D	E	ØF	G	ØI	L	M
1/8	28	~53	18	180	~152	35	13	3,2	G1/8	3,2	35	8
1/4	32	~55	22	202	~174	50	16,2	4,2	G1/4	3,5	50	7,3

VALVE / VALVOLA 3/2

SINGLE PNEUMATIC PILOT - INTERNAL PRESSURE RETURN AND SPRING
 COMANDO PNEUMATICO - RIPOSIZIONAMENTO A MOLLA PNEUMATICA E MECCANICA

K32P1.1.

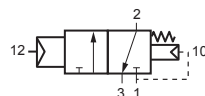
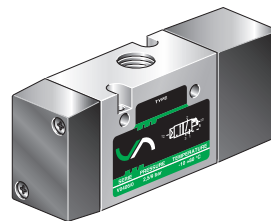
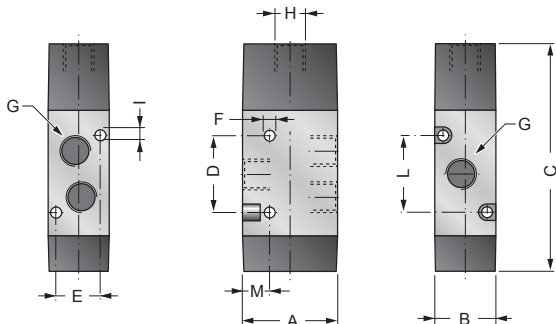

K32P161.

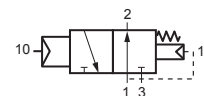

K32P191.

SIMBOLS / SIMBOLI

DIAGRAMS / DIAGRAMMI

DIAGRAM / DIAGRAMMA

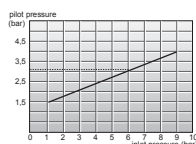

PILOT PRESSURE
 DIAGRAMMA DELLA PRESSIONE DI PILOTAGGIO

Size Taglia	A	B	C	D	E	ØF	G	H	ØI	L	M
1/8	28	18	66,2	22,2	13	3,2	G1/8	G1/8	3,2	22,2	8
1/4	32	22	75,3	29,3	16,2	4,2	G1/4	G1/8	3,5	29,3	7,3
1/2	50	30	108	45,6	-	5,2	G1/2	G1/8	-	-	11

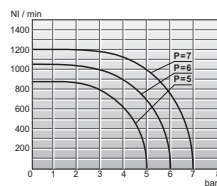

AIR FLOW DIAGRAM G1/8"
 DIAGRAMMA DELLE PORTATE G1/8"

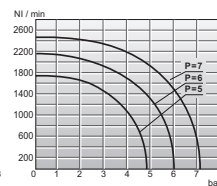

AIR FLOW DIAGRAM G1/4"
 DIAGRAMMA DELLE PORTATE G1/4"

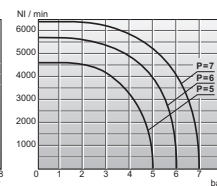

AIR FLOW DIAGRAM G1/2"
 DIAGRAMMA DELLE PORTATE G1/2"

VALVE / VALVOLA 3/2

DOUBLE PNEUMATIC PILOT / DOPPIO COMANDO PNEUMATICO

K32P201.

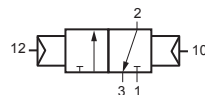
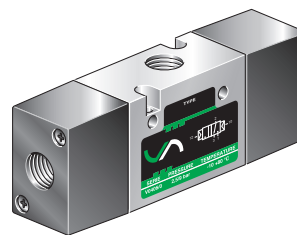
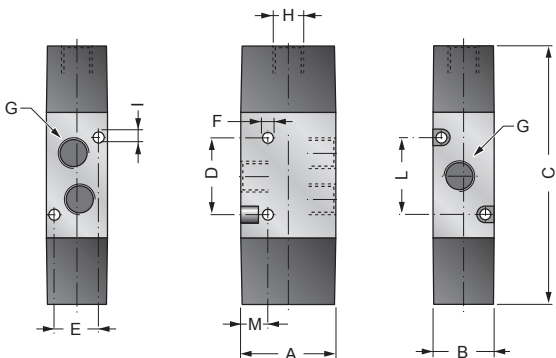

K32P201.

SIMBOL / SIMBOLO

DIAGRAMS / DIAGRAMMI

DIAGRAM / DIAGRAMMA

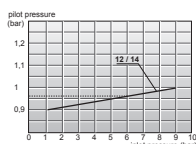

PILOT PRESSURE
 DIAGRAMMA DELLA PRESSIONE DI PILOTAGGIO

Size Taglia	A	B	C	D	E	ØF	G	H	ØI	L	M
1/8	28	18	76,2	22,2	13,5	3,2	G1/8	G1/8	3,2	22,2	8
1/4	32	22	88,3	29,3	16,2	4,2	G1/4	G1/8	3,5	29,3	7
1/2	50	30	121	45,6	-	5,2	G1/2	G1/8	-	-	11

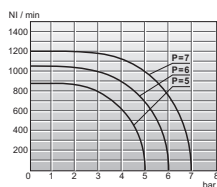

AIR FLOW DIAGRAM G1/8"
 DIAGRAMMA DELLE PORTATE G1/8"

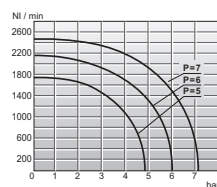

AIR FLOW DIAGRAM G1/4"
 DIAGRAMMA DELLE PORTATE G1/4"

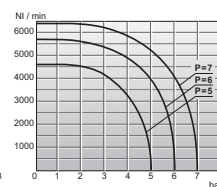

AIR FLOW DIAGRAM G1/2"
 DIAGRAMMA DELLE PORTATE G1/2"



K52P101.

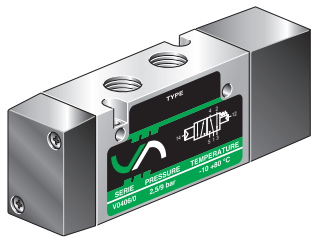

VALVE / VALVOLA 5/2
 SINGLE PNEUMATIC PILOT - INTERNAL PRESSURE RETURN AND SPRING
 COMANDO PNEUMATICO - RIPOSIZIONAMENTO A MOLLA PNEUMATICA E MECCANICA

SIMBOLS / SIMBOLI

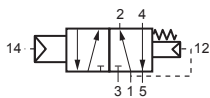

K52P1018

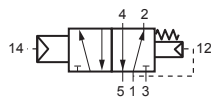

K52P1014 - K52P1012

DIAGRAMS / DIAGRAMMI

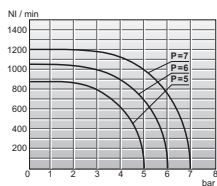

AIR FLOW DIAGRAM G1/8"
 DIAGRAMMA DELLE PORTATE G1/8"

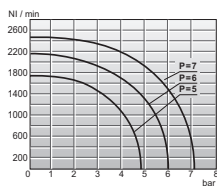

AIR FLOW DIAGRAM G1/4"
 DIAGRAMMA DELLE PORTATE G1/4"

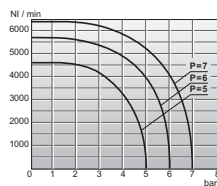

AIR FLOW DIAGRAM G1/4"
 DIAGRAMMA DELLE PORTATE G1/4"

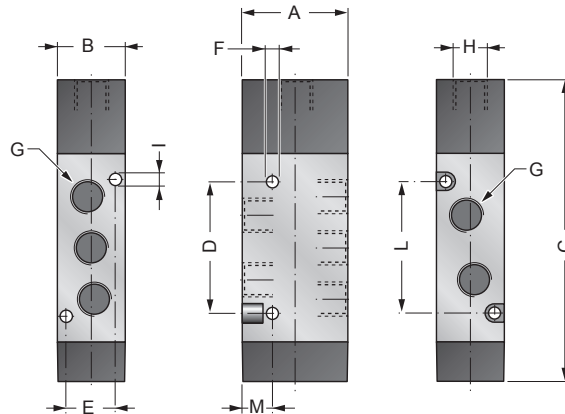
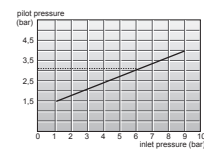

DIAGRAM / DIAGRAMMA



PILOT PRESSURE
 DIAGRAMMA DELLA PRESSIONE DI PILOTAGGIO

Size Taglia	A	B	C	D	E	ØF	G	H	ØI	L	M
1/8	28	18	80	35	13	3,2	G1/8	G1/8	3,2	35	8
1/4	32	22	96	50	16,2	4,2	G1/4	G1/8	3,5	50	7,3
1/2	50	30	137	74,6	-	5,2	G1/2	G1/8	-	-	11

K52P201.

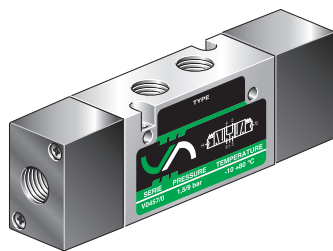

VALVE / VALVOLA 5/2
 DOUBLE PNEUMATIC PILOT / DOPPIO COMANDO PNEUMATICO

SIMBOLS / SIMBOLI

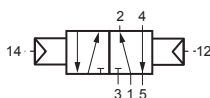

K52P2018

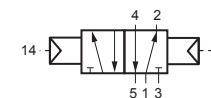

K52P2014 - K52P2012

DIAGRAMS / DIAGRAMMI

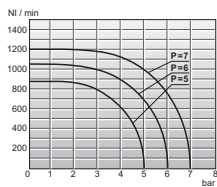

AIR FLOW DIAGRAM G1/8"
 DIAGRAMMA DELLE PORTATE G1/8"

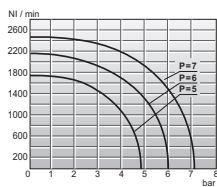

AIR FLOW DIAGRAM G1/4"
 DIAGRAMMA DELLE PORTATE G1/4"

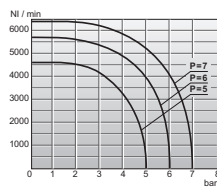

AIR FLOW DIAGRAM G1/2"
 DIAGRAMMA DELLE PORTATE G1/2"

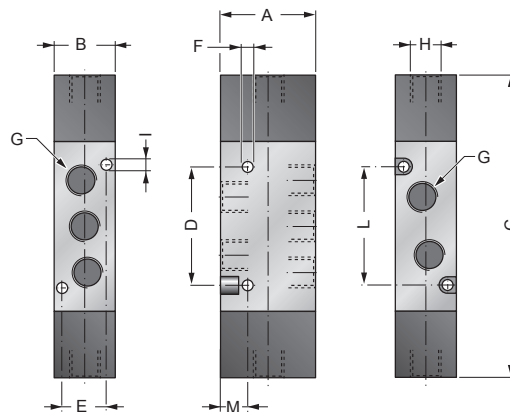
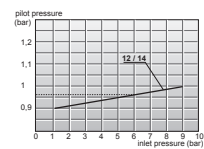

DIAGRAM / DIAGRAMMA



PILOT PRESSURE
 DIAGRAMMA DELLA PRESSIONE DI PILOTAGGIO

Size Taglia	A	B	C	D	E	ØF	G	H	ØI	L	M
1/8	28	18	89	35	13	3,2	G1/8	G1/8	3,2	35	8
1/4	32	22	109	50	16,2	4,2	G1/4	G1/8	3,5	50	7,3
1/2	50	30	108	45,6	-	5,2	G1/2	G1/8	-	-	11

K52DP21.

VALVE / 5/2
DOUBLE DIFFERENTIAL PNEUMATIC PILOT
DOPPIO COMANDO PNEUMATICO DIFFERENZIALE

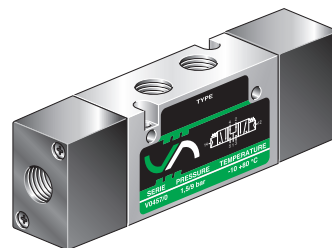
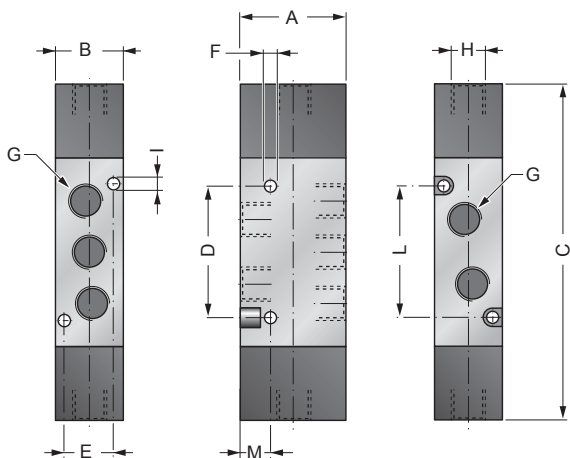

SIMBOLS /

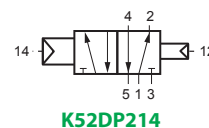
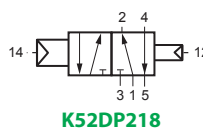

DIAGRAMS / DIAGRAMMI

DIAGRAM / DIAGRAMMA

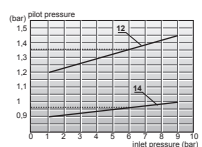

PILOT PRESSURE
DIAGRAMMA DELLA PRESSIONE DI PILOTAGGIO

Size Taglia	A	B	C	D	E	ØF	G	H	ØI	L	M
1/8	28	18	89	35	13	3,2	G1/8	G1/8	3,2	35	8
1/4	32	22	109	50	16,2	4,2	G1/4	G1/8	3,5	50	7,3

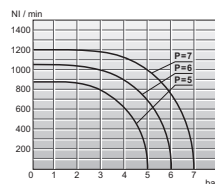

AIR FLOW DIAGRAM G1/8"
DIAGRAMMA DELLE PORTATE G1/8"

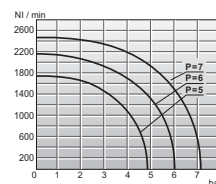

AIR FLOW DIAGRAM G1/4"
DIAGRAMMA DELLE PORTATE G1/4"

VALVE / VALVOLA 5/3

DOUBLE PNEUMATIC PILOT (MID-POSITION PRESSURIZED) / DOPPIO COMANDO PNEUMATICO (CENTRI IN PRESSIONE)
DOUBLE PNEUMATIC PILOT (MID-POSITION CLOSED) / DOPPIO COMANDO PNEUMATICO (CENTRI CHIUSI)
DOUBLE PNEUMATIC PILOT (MID-POSITION EXHAUSTED) / DOPPIO COMANDO PNEUMATICO (CENTRI APERTI)

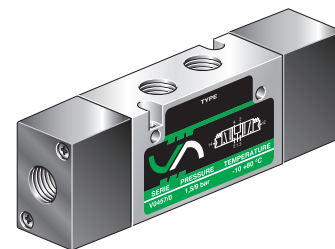
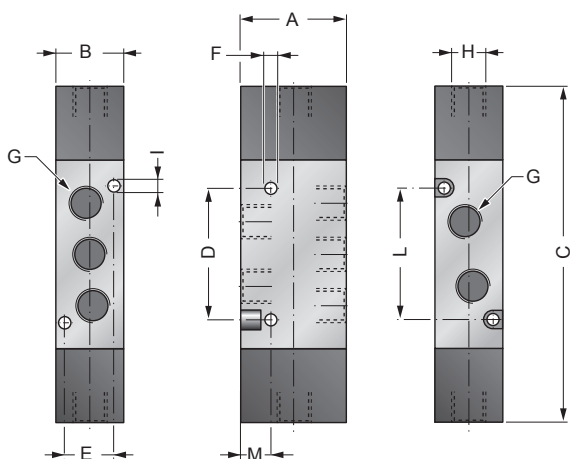

K53P2.1.

SIMBOLS / SIMBOLI

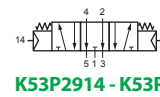
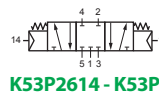
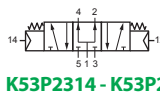
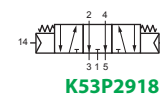
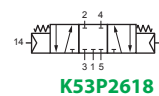
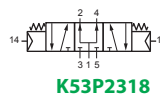

DIAGRAMS / DIAGRAMMI

DIAGRAM / DIAGRAMMA

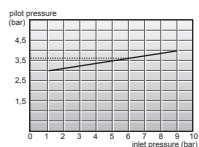

PILOT PRESSURE
DIAGRAMMA DELLA PRESSIONE DI PILOTAGGIO

Size Taglia	A	B	C	D	E	ØF	G	H	ØI	L	M
1/8	28	18	89	35	13	3,2	G1/8	G1/8	3,2	35	8
1/4	32	22	109	50	16,2	4,2	G1/4	G1/8	3,5	50	7,3
1/2	50	30	108	45,6	-	5,2	G1/2	G1/8	-	-	11

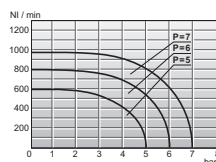

AIR FLOW DIAGRAM G 1/8"
DIAGRAMMA DELLE PORTATE G 1/8"

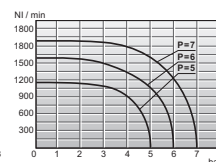

AIR FLOW DIAGRAM G 1/4"
DIAGRAMMA DELLE PORTATE G 1/4"

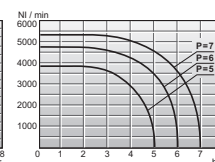

AIR FLOW DIAGRAM G 1/2"
DIAGRAMMA DELLE PORTATE G 1/2"



COILS SOLENOID VALVES AND ACCESSORIES - SOLENOIDI PER ELETTROVALVOLE ED ACCESSORI

CS

COILS
SOLENOIDI PER ELETTROVALVOLE

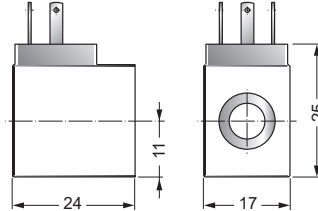
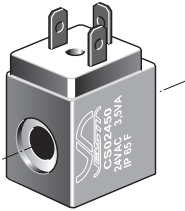

CODES / CODICI

Code ordination Codice ordinazione	Voltage Tensione
CS01200	12 V DC
CS02400	24 V DC
CS02450	24 V 50/60Hz AC
CS11050 (*)	110 V 50/60Hz AC
CS22050 (*)	220 V 50/60Hz AC

(*) Please see page / Vedi pag. B-37

TECHNICAL FEATURES

Standard tensions	12, 24, V DC 24, 110, 220 V AC (50/60 Hz)
Other tensions	Contact our commercial department
Duty cycle	100% (continuous)
Power at 20°C	2,4 Watt DC; 3,5 VA AC
Nominal tension	± 10% during normal working
Operating temperature range	-20°C ÷ +50°C
Degree of protection	Fixed plug IP 65 (IEC 144) with connector
Insulation	Class F
Materials	Wire class H - coil moulding glass filled nylon

CARATTERISTICHE TECNICHE

Tensioni standard	12, 24, V DC 24, 110, 220 V AC (50/60 Hz)
Altre tensioni	Interpellare il ns. servizio tecnico commerciale
Funzionamento	100% ED alla potenza ed alla temperatura ambiente indicata
Potenza assorbita a 20°C	2,4 Watt in DC; 3,5 VA in AC
Tensione nominale	± 10% a bobina calda
Limiti di temperatura ambiente	-20°C ÷ +50°C
Protezione	IP 65 secondo IEC 144 con connettore
Bobina	Bobina completa classe F
Materiali	Rivestimento nylon caricato vetro filo di rame classe H

CEP/0

SOLENOID CONNECTORS
CONNETTORI

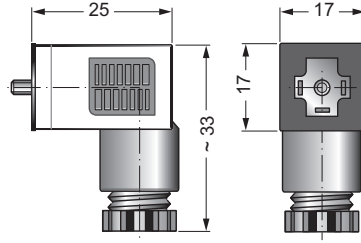
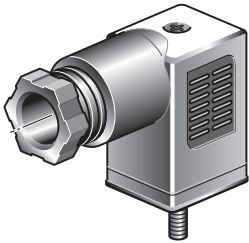

CODES / CODICI

Description Descrizione	Code Codice	Voltage Tensione
Universal connector Connettore universale	CEP/0	All tension Tutte le tensioni
Connector with led Connettore con led	CEP/0 L 10 / 50 CEP/0 L 70 / 250	10/50 V AC / DC 70/250 V AC / DC
Connector with led and varistor Connettore con led e varistore	CEP/0 LV 24 CEP/0 LV 110 CEP/0 LV 220	24 V AC / DC 110 V AC / DC 220 V AC / DC

TECHNICAL FEATURES

Wire connection	With screwed terminals
Gland thread	PG 7
Number of poles	2 Poles + earth
Housing colour	Black, transparent in the led version.

CARATTERISTICHE TECNICHE

Connessione cavi	Con morsetti a vite
Filettatura passacavo	PG 7
N° Poli	2 Poli + terra
Colori connettore	Nero, trasparente nelle versioni con led.

INSTRUCTIONS FOR USE OF THE FOLLOWING VESTA PRODUCTS

IL PRESENTE MANUALE DI USO E MANUTENZIONE È VALIDO PER I SEGUENTI PRODOTTI VESTA:

COILS SINGLES OR ASSEMBLED ON VALVES / SOLENOIDI SINGOLI O ASSEMBLATI SU ELETTROVALVOLE:

MS11050, MS22050, CS11050, CS22050, SCN11050, SCN22050

Please pay attention to the following Vesta products:

Coil and connector offer protection from dust and water to IP65 only when correctly installed with the fixing screw and rubber gasket which are supplied as standard (grommet, coil seal, "O" ring).

Prescrizioni di montaggio per preservare il grado di protezione IP65

Per preservare il grado di protezione IP65 del collegamento elettrico è necessario eseguire il montaggio nel seguente modo:

- Prima di effettuare il collegamento elettrico dei cavi al connettore infilare nel cavo stesso il pressacavo avvitando il serracavo sul connettore.
- Montare la guarnizione bobina fra bobina e connettore, quindi fissare il connettore alla bobina con l'apposita vite, avvitandola adeguatamente.
- Montare quindi la bobina sulla valvola posizionando l'anello di tenuta (OR) nell'apposita sede della bobina.

Ground connection

Ground connection must be secure and adequate.

Messa a terra

La bobina prevede il morsetto a terra che deve essere collegato opportunamente all'impianto di messa a terra dell'installazione che deve essere realizzata a regola d'arte.

Electrical connection

When choosing the cable for electrical connections, take into account the location and environment of the installation (ex. Following the CEI 60204-1 standard).

Collegamento elettrico

I conduttori utilizzati per il collegamento devono essere scelti e montati a regola d'arte tenuto conto dell'ambiente e delle condizioni di utilizzo nonché delle caratteristiche elettriche di impiego (tensione e corrente di esercizio). Si consiglia di seguire, ove applicabile, la pertinente normativa applicabile (ad es. CEI EN 60204-1).

Should the above instructions not be followed to the letter Vesta Automation will not be hold responsible.

L'installatore e l'utilizzatore sono tenuti ad attenersi scrupolosamente alle indicazioni impartite.

Qualsiasi omissione solleva Vesta Automation s.r.l. da ogni responsabilità e danno conseguenti.

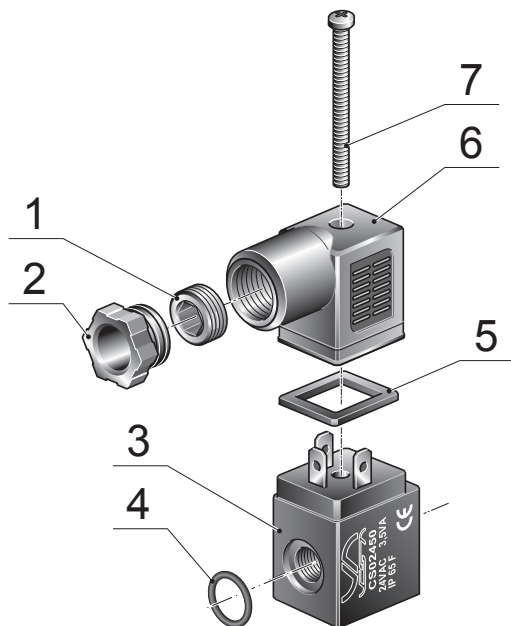

Coils and accessories for solenoid valves.
Solenoidi ed accessori per elettrovalvole.

Position Posizione	Description Descrizione
1	Grommet / Pressacavo
2	Gland nut / Serracavo
3	Solenoid coil / Bobina
4	O-Ring / OR
5	Coil seal / Guarnizione bobina
6	Connector / Connettore
7	Fixing screw / Vite